



2023

Diseñamos tu luz

2023



85 LIGHTING

DISEÑA TU LUZ

85 LIGHTING, es una empresa de nueva generación con la firme convicción de aportar nuevos valores en el sector de la Iluminación.

Desde el diseño exclusivo, la fabricación a medida y comercialización de nuestros distintos sistemas de luminarias, así como los últimos modelos en sistemas de control. 85 LIGHTING sinónimo de diseños novedosos y vanguardistas, de productos de la más alta calidad y de un servicio profesional y eficiente.

Nuestra empresa, nace para el servicio y el diseño que requiere todos nuestros clientes, como arquitectos, ingenieros, distribuidores, instaladores y propiedades, resolviendo así todas sus necesidades y recogiendo cada una de sus ideas e incorporándolas en nuestro sistema de I+D y así crear una sinergia entre 85 LIGHTING y el cliente.

Actualmente 85 LIGHTING representa un nuevo concepto en iluminación de espacios residenciales, comerciales y corporativos que busca la creación de ambientes donde la luz va más allá de la simple funcionalidad. Para nosotros iluminar significa armonizar.



DEPARTAMENTO DE ESTUDIOS Y PROYECTOS

Desde el departamento de proyectos damos una gran cobertura a todos los proyectos lumínicos de nuestros clientes, con especialistas en interior, instalaciones industriales o deportivas.

Damos a nuestro cliente la posibilidad de apoyarse en nosotros, con un servicio gratuito de proyectos luminotécnicos y un alto diseño en todos nuestros trabajos.

Hasta 5 años de garantía.

GARANTIAS

Consideramos que la calidad y la garantía de nuestros productos es un elemento fundamental para dar a nuestros clientes y al mercado, la máxima confianza.

Pretendemos asegurar la calidad de todos nuestros productos, a través de los grandes y exigentes procesos de calidad de nuestra empresa.

ÁNGULO DE APERTURA DE LA LUZ

1. ILUMINACIÓN GENERAL

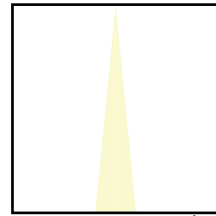
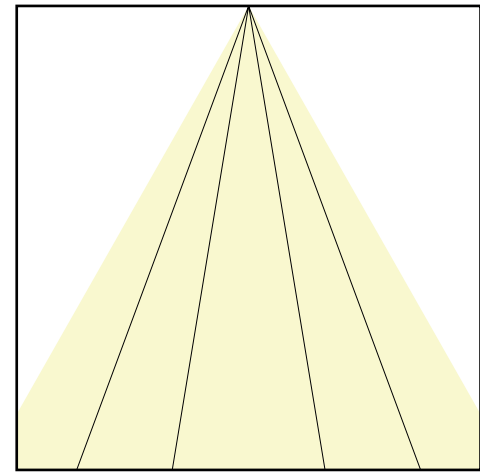

1a. ACENTUACIÓN

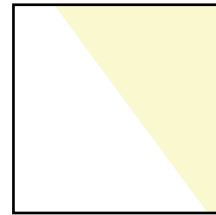

1b. BAÑADOR DE PARED

A = Intensiva 55°
B = Media 80°
C = Extensiva 120°

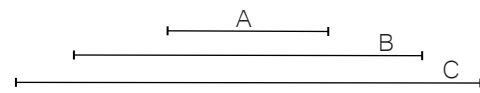

4. LÍNEA CONTINUA

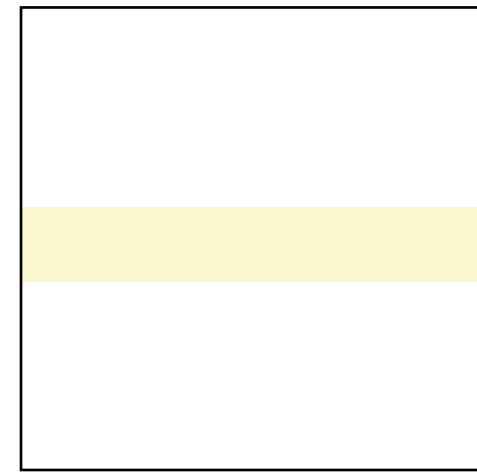

2. PROYECCIÓN

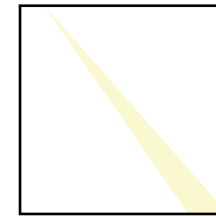
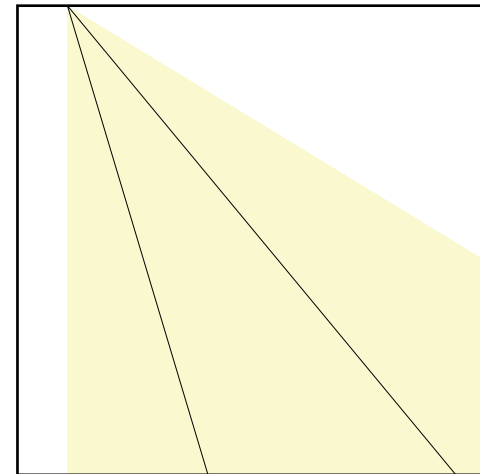

2a. ACENTUACIÓN

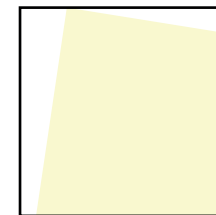

2b. BAÑADOR DE PARED

A = Intensiva
B = Media
C = Extensiva

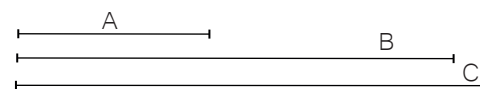

5. ILUMINACIÓN INDIRECTA

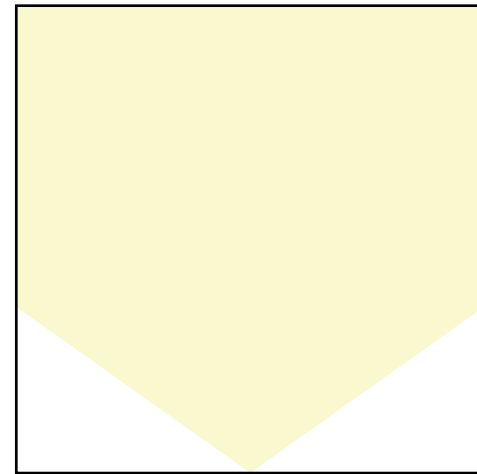

3. ORIENTACIÓN Aplicación de pared

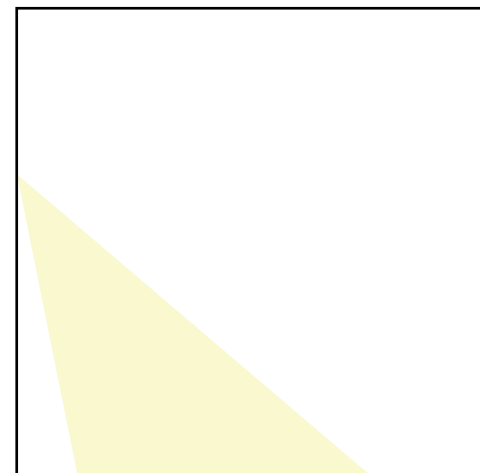

3. ORIENTACIÓN Aplicación de suelo

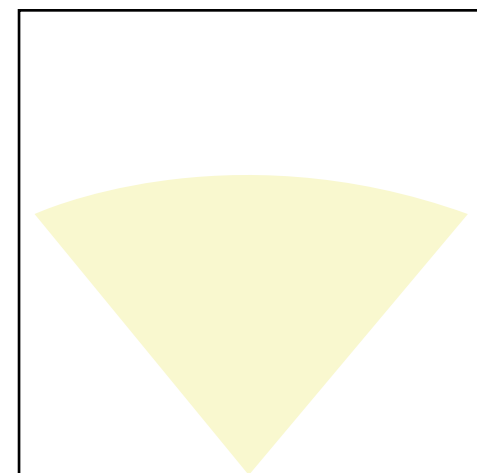

APLICABILIDAD

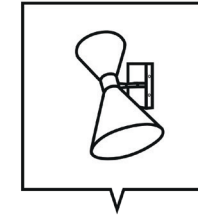

APLIQUES Y PLAFONES

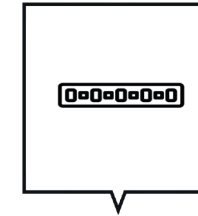

TIRAS LED Y PERFLERÍA

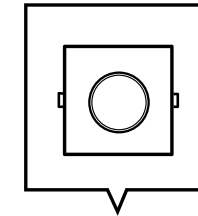

SPOT

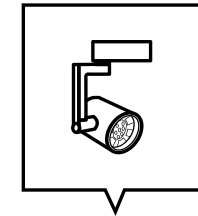

CARRILES

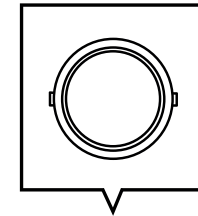

DOWNLIGHT

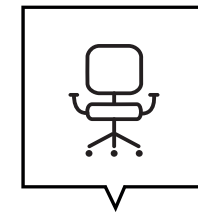

OFICINA

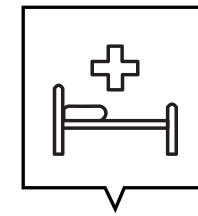

HOSPITAL

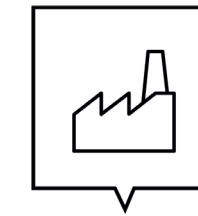

INDUSTRIAL

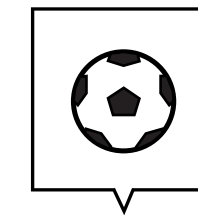

DEPORTIVA

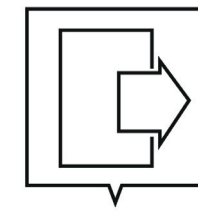

EXTERIOR

CONSTRUCCIÓN DE UNA REFERENCIA

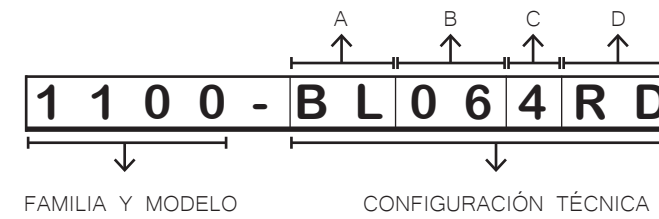

A-COLOR	B-POTENCIA	C-TONALIDAD	D-REGULACIÓN
BL BLANCO	03 3W	22 2200K	RD REGULACIÓN DALI
NG NEGRO	04 4W	2 2700K	KE KIT EMERGENCIA
RJ ROJO	06 6W	3 3000K	
AZ AZUL	12 12W	4 4000K	
VR VERDE	18 18W	4 5000K	
MD MADERA	20 20W	6 6000K	
CR CROMO MATE	25 25W	65 6500K	
TT TITANIO	30 30W		
AL ALUMINIO	40 40W		

ÍNDICE

QUIENES SOMOS _____	págs 2-3
DEPARTAMENTO DE ESTUDIOS Y PROYECTOS _____	págs 4-5
GARANTÍAS _____	págs 6-7
ÁNGULOS DE APERTURA DE LA LUZ _____	págs 8
APLICABILIDAD Y CONSTRUCCIÓN DE UNA REFENRENCIA_____	págs 9
ÍNDICE GENERAL _____	págs 10-13

APLIQUES Y PLAFONES _____ págs 14-23



TIRAS LED Y PERFILERÍA _____ págs 24-41



ÍNDICE

SPOT _____ págs 42-51



DOWNLIGHT _____ págs 52-65



CARRILES _____ págs 66-71



ÍNDICE

OFICINAS págs 72-105



INDUSTRIALES págs 106-119



HOSPITALES págs 120-125

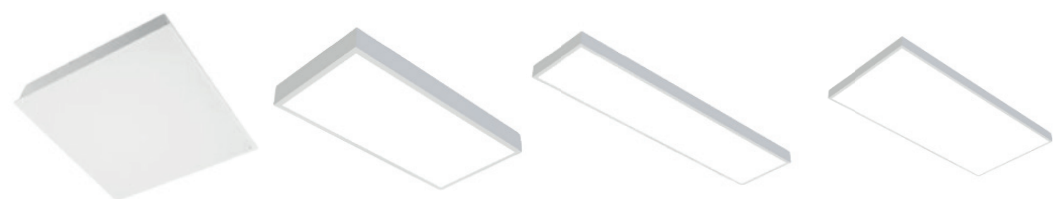

ÍNDICE

DEPORTIVA págs 126-131



EXTERIOR págs 132-151



SISTEMAS DE CONTROL págs 152-155

CONDICIONES GENERALES DE VENTA págs 156-159

APLIQUES Y PLAFONES

Luminarias para interior.

Instalación para superficie o suspensión.

Iluminación para zonas de confort.

Ideal para techos o paredes.

Aplicación para vivienda, hostelería, hoteles ...

PALLENE

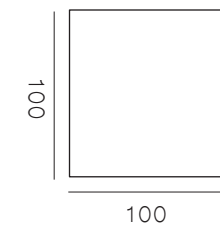

6003

A-COLOR B-POTENCIA C-TONALIDAD

<input type="checkbox"/> BL	BLANCO	<input type="checkbox"/> 6	6W	<input type="checkbox"/> 3	3000K
<input type="checkbox"/> NG	NEGRO			<input type="checkbox"/> 4	4000K
<input type="checkbox"/> GR	GRIS				
<input type="checkbox"/> IP20					

540 LÚMENES

LOSS

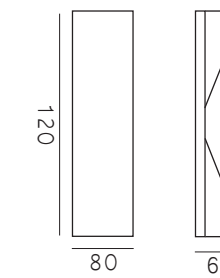

6010

A-COLOR B-POTENCIA C-TONALIDAD

<input type="checkbox"/> BL	BLANCO	<input type="checkbox"/> 6	6W	<input type="checkbox"/> 3	3000K
<input type="checkbox"/> NG	NEGRO			<input type="checkbox"/> 4	4000K
<input type="checkbox"/> IP20					

300 LÚMENES

MOBI



A-COLOR B-POTENCIA C-TONALIDAD

<input type="checkbox"/> BL	BLANCO	<input type="checkbox"/> 12	12W	<input type="checkbox"/> 3	3000K
				<input type="checkbox"/> 4	4000K
<input type="checkbox"/> IP44					

6075

1200 LÚMENES

LUN

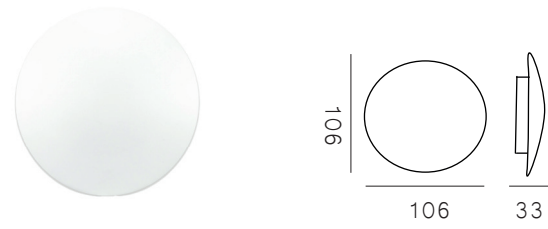

6016

A	B	C

A-COLOR	B-POTENCIA	C-TONALIDAD
<input type="checkbox"/> BL BLANCO	<input type="checkbox"/> 6 6W	<input type="checkbox"/> 4 4000K
<input type="checkbox"/> NG NEGRO		
<input type="checkbox"/> IP20		

480 LÚMENES

LUN

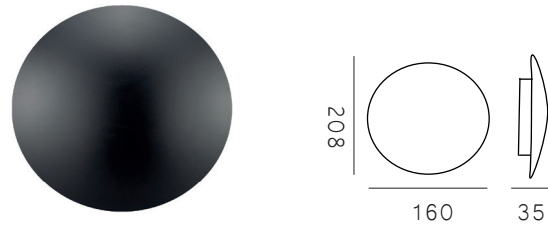

6016

A	B	C

A-COLOR	B-POTENCIA	C-TONALIDAD
<input type="checkbox"/> BL BLANCO	<input type="checkbox"/> 12 12W	<input type="checkbox"/> 4 4000K
<input type="checkbox"/> NG NEGRO		
<input type="checkbox"/> IP20		

960 LÚMENES

LUN



6016

A	B	C

A-COLOR	B-POTENCIA	C-TONALIDAD
<input type="checkbox"/> BL BLANCO	<input type="checkbox"/> 18 18W	<input type="checkbox"/> 4 4000K
<input type="checkbox"/> NG NEGRO		
<input type="checkbox"/> IP20		

1440 LÚMENES

DIRIXIM

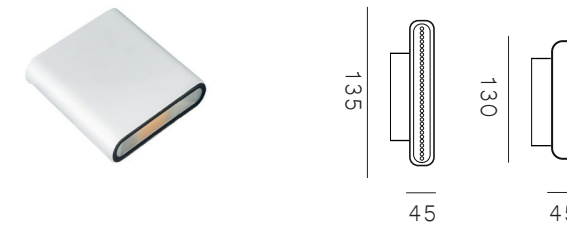

6050

A	B	C

A-COLOR	B-POTENCIA	C-TONALIDAD
<input type="checkbox"/> BL BLANCO	<input type="checkbox"/> 12 12W	<input type="checkbox"/> 4 4000K
<input type="checkbox"/> NG NEGRO		
<input type="checkbox"/> IP44		

1200 LÚMENES

LUAR MAX SUPERFICIE



5061

A	B	C

A-COLOR	B-POTENCIA	C-TONALIDAD
<input type="checkbox"/> BL BLANCO	<input type="checkbox"/> 12 12W	<input type="checkbox"/> 2 2700K
<input type="checkbox"/> NG NEGRO		<input type="checkbox"/> 4 4000K
<input type="checkbox"/> IP20		

1200 LÚMENES

LUAR MAX G2 SUPERFICIE



5062

A	B	C

A-COLOR	B-POTENCIA	C-TONALIDAD
<input type="checkbox"/> BL BLANCO	<input type="checkbox"/> 20 20W	<input type="checkbox"/> 2 2700K
<input type="checkbox"/> NG NEGRO		<input type="checkbox"/> 4 4000K
<input type="checkbox"/> IP20		

2100 LÚMENES



MANI G2



A-COLOR **B-POTENCIA** **C-TONALIDAD**

BL BLANCO 7 7W 3 3000K
 AL ALUMINIO 15 15W

IP20

630 LÚMENES
 1350 LÚMENES

5053

A	B	C

NATURE ORIENTABLE

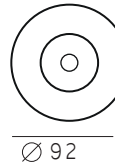

A-COLOR **B-POTENCIA** **C-TONALIDAD**

BL BLANCO 12 12W 2 2700K
 NG NEGRO 4 4000K

IP20

1200 LÚMENES

5063

A	B	C

HALDA ORIENTABLE



A-COLOR **B-POTENCIA** **C-TONALIDAD**

BL BLANCO 7 7W 3 3000K
 NG NEGRO

IP20

750 LÚMENES

5064

A	B	C

LLAL CIRCULAR G2

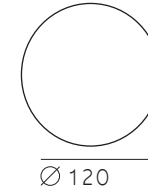

A-COLOR **B-POTENCIA** **C-TONALIDAD**

BL BLANCO 12 12W 4 4000K

IP20

1055 LÚMENES

5070

A	B	C

LLAL CIRCULAR G2

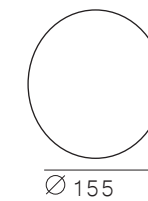

A-COLOR **B-POTENCIA** **C-TONALIDAD**

BL BLANCO 18 18W 4 4000K

IP20

2096 LÚMENES

5070

A	B	C

LLAL CIRCULAR G2

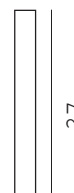
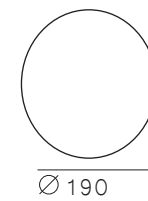

A-COLOR **B-POTENCIA** **C-TONALIDAD**

BL BLANCO 24 24W 4 4000K

IP20

2436 LÚMENES

5070

A	B	C

LLAL CUADRADO G2

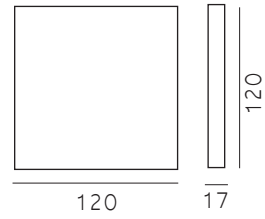

5071

A	B	C
□	□	□

A-COLOR **B-POTENCIA** **C-TONALIDAD**

BL BLANCO **12** 12W **4** 4000K

IP20

1055 LÚMENES

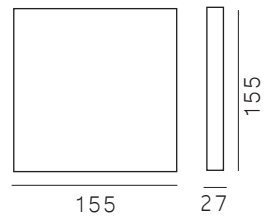

5071

A	B	C
□	□	□

A-COLOR **B-POTENCIA** **C-TONALIDAD**

BL BLANCO **18** 18W **4** 4000K

IP20

2096 LÚMENES

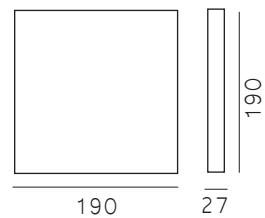

5071

A	B	C
□	□	□

A-COLOR **B-POTENCIA** **C-TONALIDAD**

BL BLANCO **24** 24W **4** 4000K

IP20

2436 LÚMENES

FOOD RED

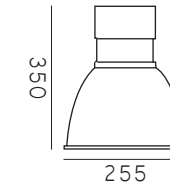

8400

A	B	C
□	□	□

A-COLOR **B-POTENCIA** **C-TONALIDAD**

RJ ROJO **28** 28W **22** 2200K

APERTURA

60°

25000 LÚMENES CRI 90

VIDA ÚTIL
50000
HORAS

IP44

FOOD BLUE

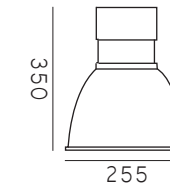

8400

A	B	C
□	□	□

A-COLOR **B-POTENCIA** **C-TONALIDAD**

AZ AZUL **28** 28W **65** 6500K

APERTURA

60°

25000 LÚMENES CRI 90

VIDA ÚTIL
50000
HORAS

IP44

PLANT GREEN

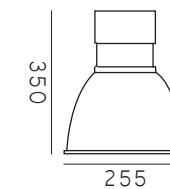

8400

A	B	C
□	□	□

A-COLOR **B-POTENCIA** **C-TONALIDAD**

VR VERDE **28** 28W **4** 4800K

APERTURA

60°

25000 LÚMENES CRI 90

VIDA ÚTIL
50000
HORAS

IP44

TIRAS LED Y PERFILERIA

ANOA G2 IP20



6600 ^B ^C

B-POTENCIA C-TONALIDAD

B-POTENCIA	C-TONALIDAD
<input type="checkbox"/> 60 60W	<input type="checkbox"/> 2 2700K
	<input type="checkbox"/> 4 4000K
	<input type="checkbox"/> 6 6000K

IP20

1500 LÚMENES/M

ANOA PRO



6600 ^B ^C

B-POTENCIA C-TONALIDAD

B-POTENCIA	C-TONALIDAD
<input type="checkbox"/> 100 100W	<input type="checkbox"/> 2 2700K
	<input type="checkbox"/> 4 4000K
	<input type="checkbox"/> 6 6000K

IP20

2650 LÚMENES/M



6700 ^B ^C

B-POTENCIA C-TONALIDAD

B-POTENCIA	C-TONALIDAD
<input type="checkbox"/> 134 134W	<input type="checkbox"/> 2 2700K
	<input type="checkbox"/> 4 4000K
	<input type="checkbox"/> 6 6000K

IP33 CRI90

3024 LÚMENES/M

Luminarias para interior o exterior .
 Instalación para superficie o para empotrar mediante perfiles .
 Iluminación para zonas de confort.
 Ideal para techos o paredes.
 Aplicación para vivienda, hostelería, hoteles ...

ANOA PRO “ESPECIAL EMBUTIDOS”



B-POTENCIA	C-TONALIDAD
76 76W	1 1900K



∅

IP20 CRI93

6700 $\frac{B}{C}$

1060 LÚMENES/M

ANOA PRO “ESPECIAL PANADERÍA”



B-POTENCIA	C-TONALIDAD
76 76W	2 2500K



IP20 CRI93

6700 $\frac{B}{C}$

1765 LÚMENES/M

ANOA PRO “ESPECIAL CARNICERÍA”



B-POTENCIA	C-TONALIDAD
76 76W	3 3100K



∅

IP20 CRI93

6700 $\frac{B}{C}$

1109 LÚMENES/M

ANOA PRO “ESPECIAL PESCADERÍA”



B-POTENCIA	C-TONALIDAD
76 76W	4 4200K



IP20 CRI93

6600 $\frac{B}{C}$

1413 LÚMENES/M

ANOA PRO “ESPECIAL FRUTERÍA”



B-POTENCIA	C-TONALIDAD
76 76W	5 5000K



IP20 CRI93

6600 $\frac{B}{C}$

1695 LÚMENES/M

ANOA PRO IP33



B-POTENCIA	C-TONALIDAD
60 60W	2 2700K
110 110W	4 4000K
	6 6000K



IP33 CRI90

6755 $\frac{B}{C}$

1550 LÚMENES



ANOA G2 IP65



B-POTENCIA	C-TONALIDAD
60 60W	2 2700K
	4 4000K
	6 6000K

IP65 CRI90

6601

1500 LÚMENES/M

ANOA G2 IP68



B-POTENCIA	C-TONALIDAD
110 110W	2 2700K
	4 4000K
	6 6000K

IP68 CRI90

6651

1550 LÚMENES

ANOA RGB IP20



B-POTENCIA	C-TONALIDAD
12 12W/M	RGB

IP20

6690

1200 LÚMENES/M

ANOA G2 IP65



A-COLOR

- ROJO
- AZUL
- VERDE

IP65 CRI90

660210220

ANOA 220 IP67



B-POTENCIA	C-TONALIDAD
10 10 W/M	3 3000K
	4 4000K
	6 6000K

IP67

6695

CONECTOR TIRA LED



Conector para tira led 220v

CR220VTL

DRIVER



7070 ^B

IP20

B-POTENCIA

35	35W
75	75W
100	100W
150	150W
200	200W
350	350W

DRIVER ESTANCO



7080 ^B

IP65

B-POTENCIA

60	60W
100	100W
150	150W
200	200W
250	250W

REGULADORES

POTENCIÓMETRO MAX.144W



8518512248

Regulado de superficie para tiras de led para monocolor.

Para tiras de potencias :
24V:<144W

POTENCIÓMETRO MAX.720W



8518304

Regulado de superficie para tiras de led para monocolor.

Para tiras de potencias :
24V:<720W

CONTROLADORES RGB

CONTROLADOR DRIVER RGB



Controlador DRIVER RGB FUT037 MI LIGHTING

MANDO CONTROL RGB



Regulado de superficie para tiras de led para monocolor.
Para tiras de potencias :
24V:<144W

8518512248

MANDO CONTROL RGB

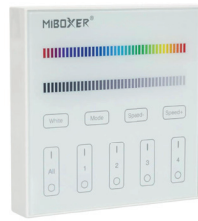

Regulado de superficie para tiras de led para monocolor.
Para tiras de potencias :
24V:<720W

8518512248

CONTROLADOR DRIVER RGB



Controlador DRIVER RGB FUT037 MI LIGHTING

8518512248

PERFIL ALUMNIO SUPERFICIE

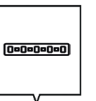

Perfil aluminio de superficie con difusor mate para tira flexible de 2m de longitud.
Medidas 2000 x 12X 7,8mm. Incluye 2 tapas garras y difusor opal

Color aluminio natural

8516128

PERFIL ALUMNIO DE EMPOTRAR



Perfil aluminio de superficie con difusor mate para tira flexible de 2m de longitud.
Medidas 2000 x 17 x 8mm
Incluye 2 tapas garras y difusor opal

Color aluminio natural

85161506

PERFIL ALUMINIO SEMICIRCULAR



Perfil aluminio semir circular de superficie con difusor mate para tira flexible de 2m de longitud.
Medidas 2000 x 19 x 19mm
ncluye 2 tapas garras y difusor opal

Color aluminio natural

85161919



PERFIL ALUMNIO EXTRAFINO



Perfil aluminio extrafino de superficie con difusor mate para tira flexible de 2m de longitud.

Medidas 2000 x 23x10mm

Incluye 2 tapas garras y difusor opal

Color aluminio natural

85162610

PERFIL ALUMNIO ESQUINA CIRCULAR



Perfil aluminio esquina circular de superficie con difusor mate para tira flexible de 2m de longitud.

Medidas 2000 x 16x16mm

Incluye 2 tapas garras y difusor opal

Color aluminio natural

8516008

SUSPENSIÓN DE CABLE DE ACERO



Perfil aluminio de empotrar con difusor mate para tira flexible de 2m de longitud.

Medidas 2000 x 23x14mm

Incluye 2 tapas garras y difusor opal

Color aluminio natural

85162315



PERFIL ALUMINIO TUBO



Perfil aluminio tubo de suspension con difusor mate para tira flexible de 2m de longitud.

Medidas 2000 x Ø30mm

Incluye 2 tapas garras y difusor opal

Color aluminio natural

8516430

PERFIL ALUMINIO TUBO



Perfil aluminio de superficie con difusor mate para tira flexible de 2m de longitud.

Medidas 2000 x 12X Ø60mm. Incluye 2 apas garras y difusor opal

Color aluminio natural

8516460

PERFIL ALUMINIO DE EMPOTRAR



Perfil aluminio de empotrar con difusor mate para tira flexible de 2m de longitud.

Medidas 2000 x23x14mm

Incluye 2 tapas garras y difusor opal

Color aluminio natural

85162315

PERFIL ALUMINIO ESQUINA CUADRADO



Perfil aluminio esquina cuadrado de superficie con difusor mate para tira flexible de 2m de longitud.

Medidas 2000 x 16x16mm

Incluye 2 tapas garras y difusor opal

Color aluminio natural

85161616

PERFIL ALUMINIO DE PARED



Perfil aluminio de pared con difusor mate para tira flexible de 2m de longitud LUZ DIRECTA E INDIRECTA.

Medidas 2000 x49X17mm

Incluye 4 tapas , 2 garras y 2 difusor opal.

Color aluminio natural

85164913

PERFIL ALUMINIO DE EMPOTRAR A SUELO



Perfil aluminio de empotrar a suelo con difusor mate para tira flexible de 2m de longitud.

Medidas 2000 x 127X11mm

Color aluminio natural

85162711





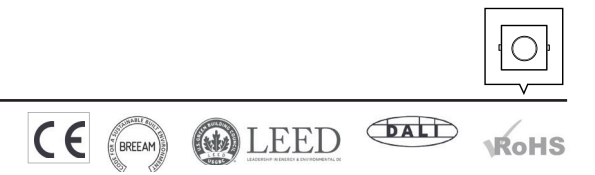

SPOT

Foco con estructura de aluminio de alta calidad.
 Instalación para superficie o empotrar.
 Fabricado en PMMA que transmite y distribuye la luz LED concentrada.
 Ideal para la instalación en techos.
 Aplicación de vivienda o retail .

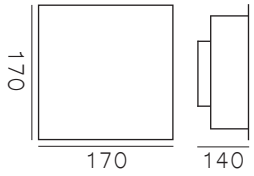
CLAXICS

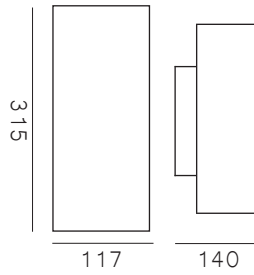

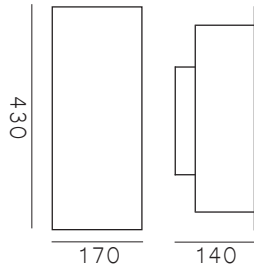
	A-COLOR	B-POTENCIA	C-TONALIDAD													
 3330 <table border="1"><tr><td>A</td><td>B</td><td>C</td></tr><tr><td>□</td><td>□</td><td>□</td></tr></table>	A	B	C	□	□	□	BL BLANCO	<table border="1"><tr><td>20</td><td>20W</td></tr><tr><td>30</td><td>30W</td></tr></table>	20	20W	30	30W	<table border="1"><tr><td>3</td><td>3000K</td></tr></table>	3	3000K	 2000 LÚMENES 3000 LÚMENES IP44
	A	B	C													
□	□	□														
20	20W															
30	30W															
3	3000K															
 3331 <table border="1"><tr><td>A</td><td>B</td><td>C</td></tr><tr><td>□</td><td>□</td><td>□</td></tr></table>	A	B	C	□	□	□	BL BLANCO	<table border="1"><tr><td>40</td><td>40W</td></tr><tr><td>60</td><td>60W</td></tr></table>	40	40W	60	60W	<table border="1"><tr><td>3</td><td>3000K</td></tr></table>	3	3000K	 4000 LÚMENES 6000 LÚMENES IP44
	A	B	C													
□	□	□														
40	40W															
60	60W															
3	3000K															
 3332 <table border="1"><tr><td>A</td><td>B</td><td>C</td></tr><tr><td>□</td><td>□</td><td>□</td></tr></table>	A	B	C	□	□	□	BL BLANCO	<table border="1"><tr><td>60</td><td>60W</td></tr><tr><td>60</td><td>60W</td></tr></table>	60	60W	60	60W	<table border="1"><tr><td>3</td><td>3000K</td></tr></table>	3	3000K	 6000 LÚMENES 9000 LÚMENES IP44
	A	B	C													
□	□	□														
60	60W															
60	60W															
3	3000K															

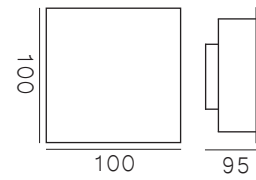

A-COLOR	B-POTENCIA	C-TONALIDAD
BL BLANCO	7 7W	2 2700K
	12 12W	

2127

A	B	C
□	□	□

700 LÚMENES
1200 LÚMENES

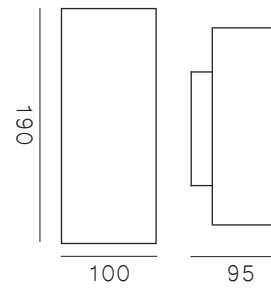

A-COLOR	B-POTENCIA	C-TONALIDAD
BL BLANCO	7 7W	2 2700K
	12 12W	

2128

A	B	C
□	□	□

1400 LÚMENES
2400 LÚMENES

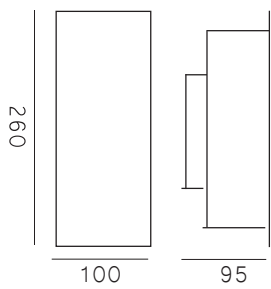

A-COLOR	B-POTENCIA	C-TONALIDAD
BL BLANCO	7 7W	2 2700K
	12 12W	

2129

A	B	C
□	□	□

2100 LÚMENES
3600 LÚMENES



MINIMAL 1

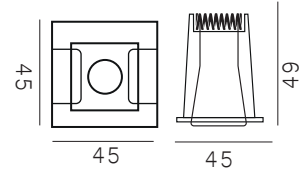
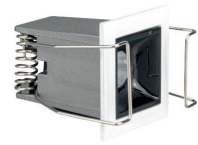

A-COLOR	B-POTENCIA	C-TONALIDAD
BL BLANCO	2 2W	3 3000K

3538

APERTURA
15°

MINIMAL 2

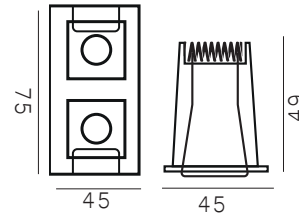

A-COLOR	B-POTENCIA	C-TONALIDAD
BL BLANCO	9 9W	3 3000K

3538

APERTURA
15°

MINIMAL 5

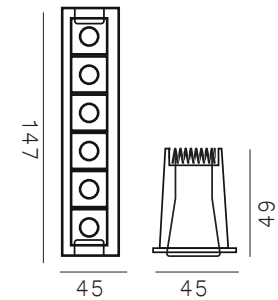

A-COLOR	B-POTENCIA	C-TONALIDAD
BL BLANCO	10 10W	3 3000K

3538

APERTURA
15°

MINIMAL 10

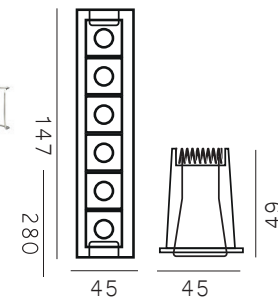

A-COLOR	B-POTENCIA	C-TONALIDAD
BL BLANCO	20 20W	3 3000K

3538

APERTURA
15°

GON G2

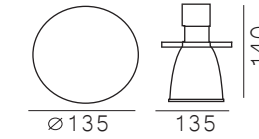

A-COLOR	B-POTENCIA	C-TONALIDAD
BL BLANCO	20 20W	3 3000K
	30 30W	4 4000K

2121

APERTURA
38°

2000 LÚMENES
3000 LÚMENES

CRI90 VIDA ÚTIL 50000 HORAS IP44

TROM NEXT

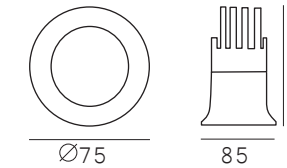

A-COLOR	B-POTENCIA	C-TONALIDAD
BL BLANCO	7 7W	2 2700K
NG NEGRO		

3334

APERTURA
38°

700 LÚMENES

CRI90 VIDA ÚTIL 50000 HORAS IP20

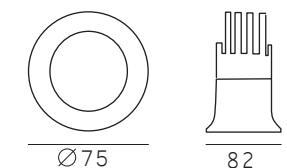

A-COLOR	B-POTENCIA	C-TONALIDAD
BL BLANCO	12 12W	3 3000K
NG NEGRO		

3334

APERTURA
38°

1200 LÚMENES

CRI90 VIDA ÚTIL 50000 HORAS IP20

SINK G2 MULTICOLOR ORIENTABLE

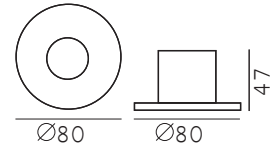

A-COLOR	B-POTENCIA	C-TONALIDAD
BL BLANCO	7 7W	00 00K

8080

700 LÚMENES

APERTURA
38°
VIDA ÚTIL 50000 HORAS
IP44

MODELO R84

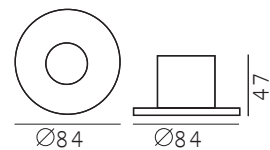

A-COLOR	B-POTENCIA	C-TONALIDAD
BL BLANCO	7 7W	2 2700K
NG NEGRO	12 12W	
CR CROMO		

3069

700 LÚMENES

APERTURA
38°
CRI95
VIDA ÚTIL 50000 HORAS
IP20

KANIX G2 CIRCULAR

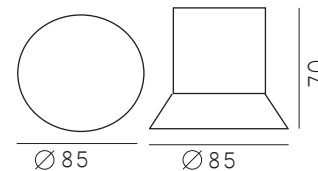

A-COLOR	B-POTENCIA	C-TONALIDAD
BL BLANCO	7 7W	2 2700K
	12 12W	

2822

705 LÚMENES
1010 LÚMENES

APERTURA
38°

KANIX G2 CUADRADO

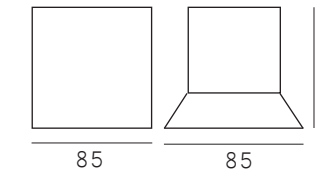

A-COLOR	B-POTENCIA	C-TONALIDAD
TT TITANIO	7 7W	2 2700K
	12 12W	

2823

705 LÚMENES
1010 LÚMENES

APERTURA
38°

MICRO SINK

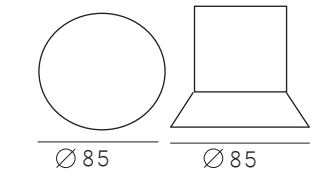

A-COLOR	B-POTENCIA	C-TONALIDAD
BL BLANCO	1 1W	3 3000K
		4 4000K

3435

100 LÚMENES

APERTURA
15°

KUF G2 CIRCULAR

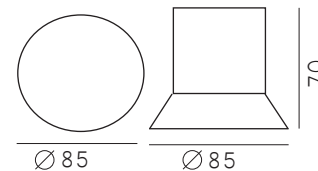

A-COLOR	B-POTENCIA	C-TONALIDAD
BL BLANCO	7 7W	2 2700K
	12 12W	

2822

705 LÚMENES
1010 LÚMENES

APERTURA
38°

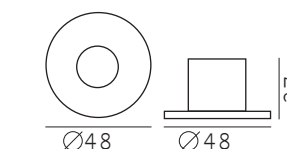

A-COLOR	B-POTENCIA	C-TONALIDAD
BL BLANCO	3 3W	3 3000K
NG NEGRO		4 4000K

3336

300 LÚMENES

APERTURA
15°

VIDA ÚTIL 50000 HORAS	IP20
-----------------------	------



PIRAM

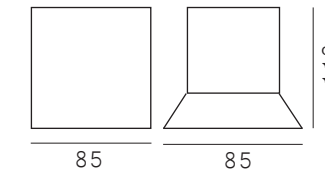

2125

A-COLOR	B-POTENCIA	C-TONALIDAD
<input type="checkbox"/> BLANCO	<input type="checkbox"/> 7W <input type="checkbox"/> 12W	<input type="checkbox"/> 2700K

APERTURA

38°

700 LÚMENES
1200 LÚMENES

PIRAM ASIMÉTRICO

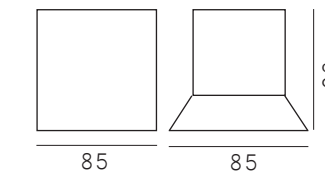

2126

A-COLOR	B-POTENCIA	C-TONALIDAD
<input type="checkbox"/> BLANCO	<input type="checkbox"/> 7W <input type="checkbox"/> 12W	<input type="checkbox"/> 2700K

APERTURA

38°

700 LÚMENES
1200 LÚMENES

DOWNLIGHT



Luminaria downlight con estructura de aluminio de alta calidad.

Instalación para superficie o empotrar.

Fabricado en PMMA que transmite y distribuye la luz LED de forma uniforme.

Ideal para la instalación en techo.

Aplicación de vivienda, oficinas o retail.

LUAR

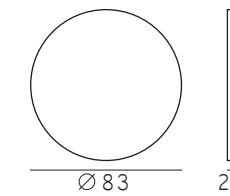

1100

A	B	C
□	□	□

A-COLOR B-POTENCIA C-TONALIDAD

BL BLANCO	3 3W	3 3000K
		4 4000K
		6 6000K

APERTURA

120°

300 LÚMENES

VIDA ÚTIL
50000
HORAS

IP44

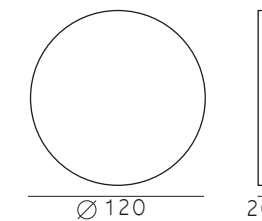

1101

A	B	C
□	□	□

A-COLOR B-POTENCIA C-TONALIDAD

BL BLANCO	6 6W	3 3000K
		4 4000K
		6 6000K

APERTURA

120°

600 LÚMENES

VIDA ÚTIL
50000
HORAS

IP44

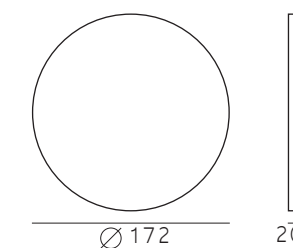

1102

A	B	C
□	□	□

A-COLOR B-POTENCIA C-TONALIDAD

BL BLANCO	12 12W	3 3000K
		4 4000K
		6 6000K

APERTURA

120°

1200 LÚMENES

VIDA ÚTIL
50000
HORAS

IP44

LUAR

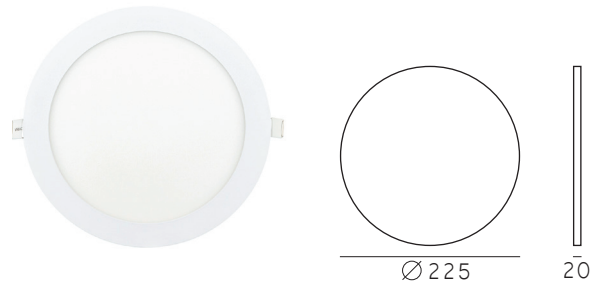

1103 A B C D

A-COLOR	B-POTENCIA	C-TONALIDAD
<input type="checkbox"/> BL BLANCO	<input type="checkbox"/> 18 18W	<input type="checkbox"/> 3 3000K
		<input type="checkbox"/> 4 4000K
		<input type="checkbox"/> 6 6000K
APERTURA		
<input type="checkbox"/> 120°		
1800 LÚMENES		
		<input type="checkbox"/> VIDA ÚTIL 50000 HORAS
		<input type="checkbox"/> IP44

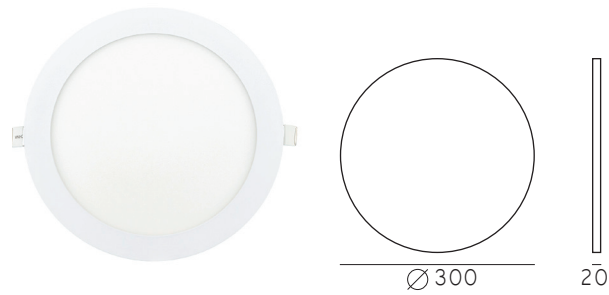

1104 A B C D

A-COLOR	B-POTENCIA	C-TONALIDAD
<input type="checkbox"/> BL BLANCO	<input type="checkbox"/> 25 25W	<input type="checkbox"/> 3 3000K
		<input type="checkbox"/> 4 4000K
		<input type="checkbox"/> 6 6000K
APERTURA		
<input type="checkbox"/> 120°		
2500 LÚMENES		
		<input type="checkbox"/> VIDA ÚTIL 50000 HORAS
		<input type="checkbox"/> IP44

LUAR CUADRADO

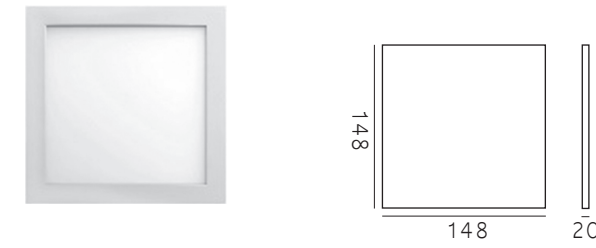

1300 A B C D

A-COLOR	B-POTENCIA	C-TONALIDAD
<input type="checkbox"/> BL BLANCO	<input type="checkbox"/> 9 9W	<input type="checkbox"/> 3 3000K
		<input type="checkbox"/> 4 4000K
		<input type="checkbox"/> 6 6000K
APERTURA		
<input type="checkbox"/> 120°		
900 LÚMENES		
		<input type="checkbox"/> VIDA ÚTIL 50000 HORAS
		<input type="checkbox"/> IP44

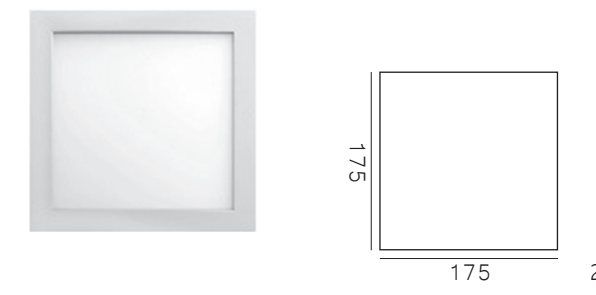

1301 A B C D

A-COLOR	B-POTENCIA	C-TONALIDAD
<input type="checkbox"/> BL BLANCO	<input type="checkbox"/> 15 15W	<input type="checkbox"/> 3 3000K
		<input type="checkbox"/> 4 4000K
		<input type="checkbox"/> 6 6000K
APERTURA		
<input type="checkbox"/> 120°		
1500 LÚMENES		
		<input type="checkbox"/> VIDA ÚTIL 50000 HORAS
		<input type="checkbox"/> IP44

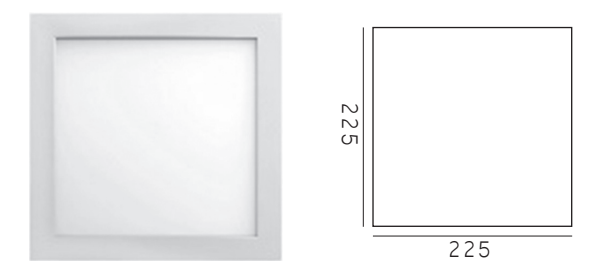

1302 A B C D

A-COLOR	B-POTENCIA	C-TONALIDAD
<input type="checkbox"/> BL BLANCO	<input type="checkbox"/> 18 18W	<input type="checkbox"/> 3 3000K
		<input type="checkbox"/> 4 4000K
		<input type="checkbox"/> 6 6000K
APERTURA		
<input type="checkbox"/> 120°		
1800 LÚMENES		
		<input type="checkbox"/> VIDA ÚTIL 50000 HORAS
		<input type="checkbox"/> IP44



LUAR SUPERFICIE CIRCULAR

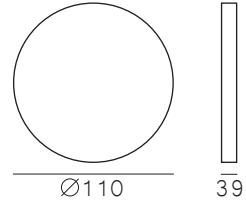

2000 A B C

A-COLOR **B-POTENCIA** **C-TONALIDAD**

<input type="checkbox"/> BL BLANCO	<input type="checkbox"/> 6 6W	<input type="checkbox"/> 3 3000K
		<input type="checkbox"/> 4 4000K
		<input type="checkbox"/> 6 6000K

600 LÚMENES

VIDA ÚTIL 50000 HORAS

IP44

LUAR SUPERFICIE CIRCULAR

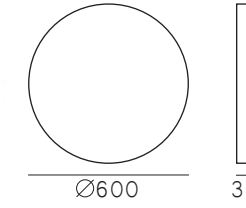

2000 A B C

A-COLOR **B-POTENCIA** **C-TONALIDAD**

<input type="checkbox"/> BL BLANCO	<input type="checkbox"/> 48 48W	<input type="checkbox"/> 4 4000K
------------------------------------	---------------------------------	----------------------------------

4600 LÚMENES

VIDA ÚTIL 50000 HORAS

IP44

LUAR SUPERFICIE CUADRADO

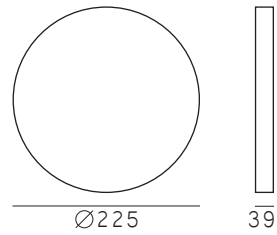

2000 A B C

A-COLOR **B-POTENCIA** **C-TONALIDAD**

<input type="checkbox"/> BL BLANCO	<input type="checkbox"/> 18 18W	<input type="checkbox"/> 3 3000K
		<input type="checkbox"/> 4 4000K
		<input type="checkbox"/> 6 6000K

1800 LÚMENES

VIDA ÚTIL 50000 HORAS

IP44

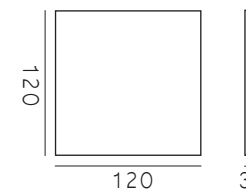

2100 A B C

A-COLOR **B-POTENCIA** **C-TONALIDAD**

<input type="checkbox"/> BL BLANCO	<input type="checkbox"/> 6 6W	<input type="checkbox"/> 3 3000K
		<input type="checkbox"/> 4 4000K
		<input type="checkbox"/> 6 6000K

600 LÚMENES

VIDA ÚTIL 50000 HORAS

IP44

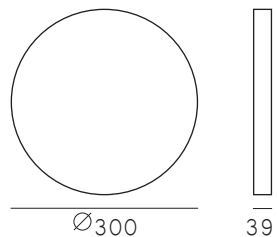

2000 A B C

A-COLOR **B-POTENCIA** **C-TONALIDAD**

<input type="checkbox"/> BL BLANCO	<input type="checkbox"/> 24 24W	<input type="checkbox"/> 4 4000K
------------------------------------	---------------------------------	----------------------------------

2400 LÚMENES

VIDA ÚTIL 50000 HORAS

IP44

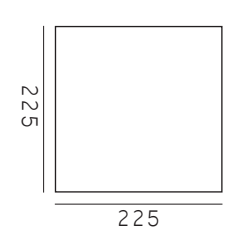

2100 A B C

A-COLOR **B-POTENCIA** **C-TONALIDAD**

<input type="checkbox"/> BL BLANCO	<input type="checkbox"/> 18 18W	<input type="checkbox"/> 3 3000K
		<input type="checkbox"/> 4 4000K
		<input type="checkbox"/> 6 6000K

1800 LÚMENES

VIDA ÚTIL 50000 HORAS

IP44



GRAXEX

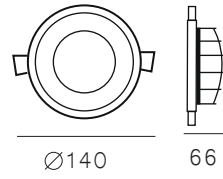

2231 A B C

A-COLOR	B-POTENCIA	C-TONALIDAD
<input type="checkbox"/> BL BLANCO	<input type="checkbox"/> 20 20W	<input type="checkbox"/> 4 4000K

2400 LÚMENES

APERTURA
<input type="checkbox"/> 90°
<input type="checkbox"/> VIDA UTIL 95000 HORAS
<input type="checkbox"/> IP44

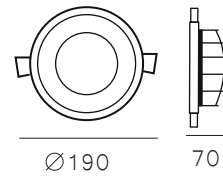

2231 A B C

A-COLOR	B-POTENCIA	C-TONALIDAD
<input type="checkbox"/> BL BLANCO	<input type="checkbox"/> 30 30W	<input type="checkbox"/> 4 4000K

3000 LÚMENES

APERTURA
<input type="checkbox"/> 90°
<input type="checkbox"/> VIDA UTIL 95000 HORAS
<input type="checkbox"/> IP44

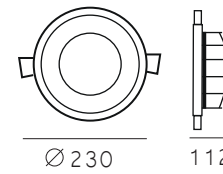

2231 A B C

A-COLOR	B-POTENCIA	C-TONALIDAD
<input type="checkbox"/> BL BLANCO	<input type="checkbox"/> 60 60W	<input type="checkbox"/> 4 4000K

6000 LÚMENES

APERTURA
<input type="checkbox"/> 90°
<input type="checkbox"/> VIDA UTIL 95000 HORAS
<input type="checkbox"/> IP44

BRIGHT

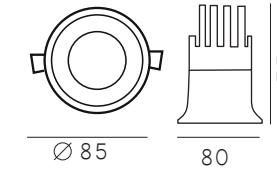

2124 A B C

A-COLOR	B-POTENCIA	C-TONALIDAD
<input type="checkbox"/> BL BLANCO	<input type="checkbox"/> 12 12W	<input type="checkbox"/> 3 3000K
		<input type="checkbox"/> 4 4000K

1200 LÚMENES

APERTURA
<input type="checkbox"/> 24°
<input type="checkbox"/> CRI90
<input type="checkbox"/> IP44

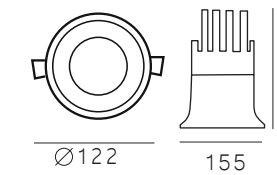

2124 A B C

A-COLOR	B-POTENCIA	C-TONALIDAD
<input type="checkbox"/> BL BLANCO	<input type="checkbox"/> 25 25W	<input type="checkbox"/> 3 3000K
		<input type="checkbox"/> 4 4000K

2500 LÚMENES

APERTURA
<input type="checkbox"/> 24°
<input type="checkbox"/> CRI90
<input type="checkbox"/> IP44

XILEF NEXT

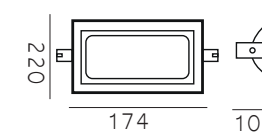

3232 A B C

A-COLOR	B-POTENCIA	C-TONALIDAD
<input type="checkbox"/> BL BLANCO	<input type="checkbox"/> 30 30W	<input type="checkbox"/> 3 3000K
		<input type="checkbox"/> 4 4000K
		<input type="checkbox"/> 6 6000K

4500 LÚMENES

APERTURA
<input type="checkbox"/> 100°
<input type="checkbox"/> VIDA UTIL 95000 HORAS
<input type="checkbox"/> IP44



XILEF NEXT CIRCULAR



3350

A	B	C
□	□	□

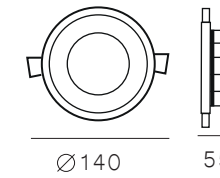

A-COLOR	B-POTENCIA	C-TONALIDAD
BL BLANCO	16 16W	4 4000K

APERTURA
105°
VIDA ÚTIL 95000 HORAS
IP44

1405 LÚMENES



3350

A	B	C
□	□	□

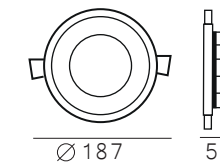

A-COLOR	B-POTENCIA	C-TONALIDAD
BL BLANCO	21 21W	4 4000K

APERTURA
105°
VIDA ÚTIL 95000 HORAS
IP44

1905 LÚMENES



3350

A	B	C
□	□	□

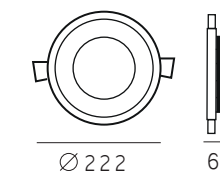

A-COLOR	B-POTENCIA	C-TONALIDAD
BL BLANCO	30 30W	4 4000K

APERTURA
105°
IP44

3050 LÚMENES



PROYECTOR TRIFÁSICO

VEDRA

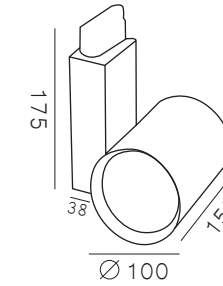

A-COLOR	B-POTENCIA	C-TONALIDAD
<input type="checkbox"/> BL BLANCO	<input type="checkbox"/> 30 30W	<input type="checkbox"/> 3 3000K
<input type="checkbox"/> NG NEGRO		<input type="checkbox"/> 4 4000K
		<input type="checkbox"/> 6 6000K
APERTURA		
<input type="checkbox"/> 38°		
2700 LÚMENES		<input type="checkbox"/> CRI95 <input type="checkbox"/> VIDA ÚTIL 50000 HORAS <input type="checkbox"/> IP44

7003 A B C D

CARRILES

FIYI

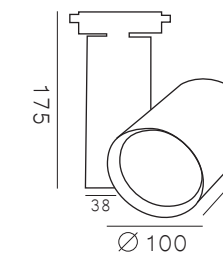

A-COLOR	B-POTENCIA	C-TONALIDAD
<input type="checkbox"/> BL BLANCO	<input type="checkbox"/> 30 30W	<input type="checkbox"/> 3 3000K
<input type="checkbox"/> NG NEGRO		<input type="checkbox"/> 4 4000K
		<input type="checkbox"/> 6 6000K
APERTURA		
<input type="checkbox"/> 24°		
3000 LÚMENES		<input type="checkbox"/> CRI95

7010 A B C

BEKA

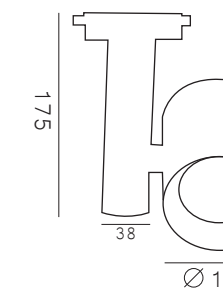

A-COLOR	B-POTENCIA	C-TONALIDAD
<input type="checkbox"/> BL BLANCO	<input type="checkbox"/> 30 30W	<input type="checkbox"/> 3 3000K
<input type="checkbox"/> NG NEGRO		<input type="checkbox"/> 4 4000K
		<input type="checkbox"/> 6 6000K
APERTURA		
<input type="checkbox"/> 38°		
2700 LÚMENES		<input type="checkbox"/> CRI95

7015 A B C

Proyector con estructura de aluminio de alta calidad.

Instalación para superficie.

Fabricado en PMMA que transmite y distribuye la luz LED con diferentes grados de apertura.

Ideal para la instalación en techos.

Aplicación para retail .



CARRIL DE SUPERFICIE TRIFÁSICO



A-MEDIDAS	B-COLOR
1 1 mm	BL BLANCO
2 2 mm	NG NEGRO

STRIC $\begin{matrix} A & B \\ \square & \square \end{matrix}$

CARRIL DE EMPOTRAR TRIFÁSICO



A-MEDIDAS	B-COLOR
1 1 mm	BL BLANCO
2 2 mm	NG NEGRO

ETRIC $\begin{matrix} A & B \\ \square & \square \end{matrix}$

CONECTOR CARRIL



A-COLOR	B-SALIDAS
BL BLANCO	
NG NEGRO	

85TCTEB $\begin{matrix} A & B \\ \square & \square \end{matrix}$

UNIÓN INTERMEDIA PARA CARRIL



A-COLOR
BL BLANCO
NG NEGRO

85TCTEN $\begin{matrix} A & B \\ \square & \square \end{matrix}$

UNIÓN INTERMEDIA PARA CARRIL EN FORMA DE L



A-COLOR
BL BLANCO
NG NEGRO

85TCTEN $\begin{matrix} A & B \\ \square & \square \end{matrix}$

UNIÓN PARA CARRIL EN FORMA DE T



A-COLOR
BL BLANCO
NG NEGRO

85TCTEB $\begin{matrix} A & B \\ \square & \square \end{matrix}$

UNIÓN INTERMEDIA PARA CARRIL EN FORMA DE X

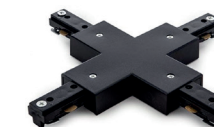

A-COLOR
BL BLANCO
NG NEGRO

85TCTEB $\begin{matrix} A & B \\ \square & \square \end{matrix}$



OFICINAS



5501

A	B	C	S
<input type="checkbox"/>	<input type="checkbox"/>	<input type="checkbox"/>	<input type="checkbox"/>

A-COLOR	B-POTENCIA	LÚMENES	C-TONALIDAD	APERTURA
<input type="checkbox"/> BL BLANCO	<input type="checkbox"/> 24 24W	2850	<input type="checkbox"/> 3 3000K	<input type="checkbox"/> 100°
<input checked="" type="checkbox"/> NG NEGRO	<input type="checkbox"/> 36 36W	3915	<input type="checkbox"/> 4 4000K	
<input type="checkbox"/> GR GRIS	<input type="checkbox"/> 51 51W	5190	<input type="checkbox"/> 5 5000K	

DIMENSIONES	DIFUSOR	S-SUSPENSION
∅370X100 mm	<ul style="list-style-type: none"> • OPAL (Se suministrará de manera estandar) • MICROPRISMÁTICO 	MEDIDA ESTANDAR 1500mm *Otras medidas a consultar

Luminarias de fabricación a medida, formatos en chapa y aluminio de alta calidad.

Instalación para empotrar, superficie.

Transmite y distribuye la luz LED con diferentes difusores para cumplir con el deslumbramiento.

Ideal para la instalación en techos.

Aplicación para oficinas.

5 años de garantía.





5500

A	B	C	S
<input type="checkbox"/>	<input type="checkbox"/>	<input type="checkbox"/>	<input type="checkbox"/>

5502

A	B	C	S
<input type="checkbox"/>	<input type="checkbox"/>	<input type="checkbox"/>	<input type="checkbox"/>

A-COLOR	B-POTENCIA	LÚMENES	C-TONALIDAD	APERTURA
<input type="checkbox"/> BL BLANCO	<input type="checkbox"/> 48 48W	5700	<input type="checkbox"/> 3 3000K	<input type="checkbox"/> 100°
<input checked="" type="checkbox"/> NG NEGRO	<input type="checkbox"/> 71 71W	7830	<input type="checkbox"/> 4 4000K	
<input type="checkbox"/> GR GRIS	<input type="checkbox"/> 102 102W	10380	<input type="checkbox"/> 5 5000K	

A-COLOR	B-POTENCIA	LÚMENES	C-TONALIDAD	APERTURA
<input type="checkbox"/> BL BLANCO	<input type="checkbox"/> 110 110W	12825	<input type="checkbox"/> 3 3000K	<input type="checkbox"/> 100°
<input checked="" type="checkbox"/> NG NEGRO	<input type="checkbox"/> 160 160W	17955	<input type="checkbox"/> 4 4000K	
<input type="checkbox"/> GR GRIS	<input type="checkbox"/> 230 230W	23355	<input type="checkbox"/> 5 5000K	

DIMENSIONES	DIFUSOR	S-SUSPENSIÓN
∅550X100 mm	<ul style="list-style-type: none"> • OPAL (Se suministrará de manera estandar) • MICROPRISMÁTICO 	MEDIDA ESTANDAR 1500mm *Otras medidas a consultar

DIMENSIONES	DIFUSOR	S-SUSPENSIÓN
∅800X100 mm	<ul style="list-style-type: none"> • OPAL (Se suministrará de manera estandar) • MICROPRISMÁTICO 	MEDIDA ESTANDAR 1500mm *Otras medidas a consultar





5600

A	B	C	S
<input type="checkbox"/>	<input type="checkbox"/>	<input type="checkbox"/>	<input type="checkbox"/>

A-COLOR	B-POTENCIA	LÚMENES	C-TONALIDAD	APERTURA
<input type="checkbox"/> BL BLANCO	<input type="checkbox"/> 48 48W	5700	<input type="checkbox"/> 3 3000K	<input type="checkbox"/> 100°
<input checked="" type="checkbox"/> NG NEGRO	<input type="checkbox"/> 71 71W	7830	<input type="checkbox"/> 4 4000K	
<input type="checkbox"/> GR GRIS	<input type="checkbox"/> 102 102W	10380	<input type="checkbox"/> 5 5000K	

DIMENSIONES	DIFUSOR	S-SUSPENSIÓN
∅550X100 mm	<ul style="list-style-type: none"> • OPAL (Se suministrará de manera estandar) • MICROPRISMÁTICO 	MEDIDA ESTANDAR 1500mm *Otras medidas a consultar



5601

A	B	C	S
<input type="checkbox"/>	<input type="checkbox"/>	<input type="checkbox"/>	<input type="checkbox"/>

A-COLOR	B-POTENCIA	LÚMENES	C-TONALIDAD	APERTURA
<input type="checkbox"/> BL BLANCO	<input type="checkbox"/> 110 110W	12825	<input type="checkbox"/> 3 3000K	<input type="checkbox"/> 100°
<input checked="" type="checkbox"/> NG NEGRO	<input type="checkbox"/> 160 160W	17955	<input type="checkbox"/> 4 4000K	
<input type="checkbox"/> GR GRIS	<input type="checkbox"/> 230 230W	23355	<input type="checkbox"/> 5 5000K	

DIMENSIONES	DIFUSOR	S-SUSPENSIÓN
∅800X100 mm	<ul style="list-style-type: none"> • OPAL (Se suministrará de manera estandar) • MICROPRISMÁTICO 	MEDIDA ESTANDAR 1500mm *Otras medidas a consultar

FABRICACIÓN

A MEDIDA



FABRICACIÓN A MEDIDA

STYLELINE de superficie y suspensión A58



4891 A B C S

A-COLOR	B-POTENCIA	LÚMENES	C-TONALIDAD	APERTURA
<input type="checkbox"/> BL BLANCO	<input type="checkbox"/> 12 12W	1320	<input type="checkbox"/> 3 3000K	<input type="checkbox"/> 100°
<input type="checkbox"/> NG NEGRO	<input type="checkbox"/> 17 17W	1870	<input type="checkbox"/> 4 4000K	
<input type="checkbox"/> GR GRIS	<input type="checkbox"/> 25 25W	2750	<input type="checkbox"/> 5 5000K	

DIMENSIONES	DIFUSOR	S-SUSPENSIÓN
<input type="checkbox"/> 560X58X75mm *Otras medidas a consultar	• OPAL (Se suministrará de manera estandar) • MICROPRISMÁTICO	MEDIDA ESTANDAR 1500mm *Otras medidas a consultar

ÁNGULO DE APERTURA

- ASIMÉTRICO
- DE 100°



STYLELINE de suspensión A58



1130X58X75 mm
*Otras medidas a consultar

4892 A B C S

A-COLOR	B-POTENCIA	LÚMENES	C-TONALIDAD	APERTURA
<input type="checkbox"/> BL BLANCO	<input type="checkbox"/> 24 24W	2640	<input type="checkbox"/> 3 3000K	<input type="checkbox"/> 100°
<input type="checkbox"/> NG NEGRO	<input type="checkbox"/> 35 35W	3850	<input type="checkbox"/> 4 4000K	
<input type="checkbox"/> GR GRIS	<input type="checkbox"/> 51 51W	5610	<input type="checkbox"/> 5 5000K	

DIFUSOR	ÁNGULO DE APERTURA	S-SUSPENSIÓN
• OPAL (Se suministrará de manera estandar) • MICROPRISMÁTICO	• ASIMÉTRICO • DE 100°	MEDIDA ESTANDAR 1500mm *Otras medidas a consultar

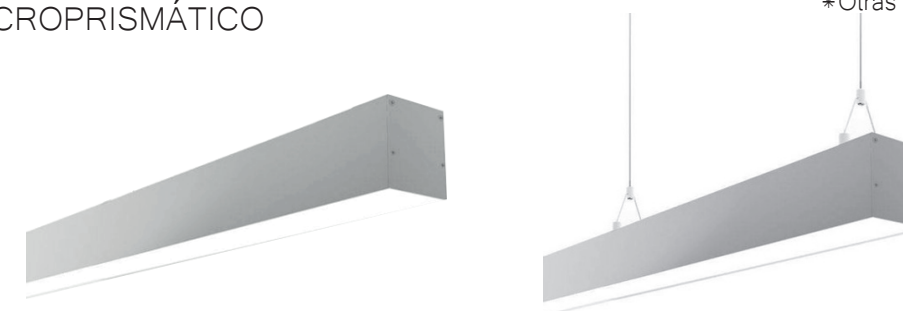

1400X58X75 mm
*Otras medidas a consultar

4893 A B C S

A-COLOR	B-POTENCIA	LÚMENES	C-TONALIDAD	APERTURA
<input type="checkbox"/> BL BLANCO	<input type="checkbox"/> 30 30W	3300	<input type="checkbox"/> 3 3000K	<input type="checkbox"/> 100°
<input type="checkbox"/> NG NEGRO	<input type="checkbox"/> 40 44W	4840	<input type="checkbox"/> 4 4000K	
<input type="checkbox"/> GR GRIS	<input type="checkbox"/> 64 64W	7040	<input type="checkbox"/> 5 5000K	

DIFUSOR	ÁNGULO DE APERTURA	S-SUSPENSIÓN
• OPAL (Se suministrará de manera estandar) • MICROPRISMÁTICO	• ASIMÉTRICO • DE 100°	MEDIDA ESTANDAR 1500mm *Otras medidas a consultar







STYLINE EMPOTRAR A58

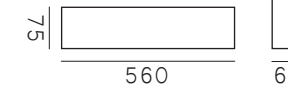
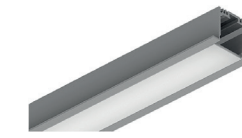

4853 A B C D

A-COLOR	B-POTENCIA	C-TONALIDAD
---------	------------	-------------

<input type="checkbox"/> BL BLANCO	<input type="checkbox"/> 12 12W	<input type="checkbox"/> 3 3000K
	<input type="checkbox"/> 17 17W	<input type="checkbox"/> 4 4000K
	<input type="checkbox"/> 25 25W	<input type="checkbox"/> 5 5000K

1320 LÚMENES
1870 LÚMENES
2750 LÚMENES

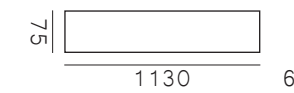
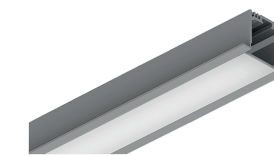

4851 A B C D

A-COLOR	B-POTENCIA	C-TONALIDAD
---------	------------	-------------

<input type="checkbox"/> BL BLANCO	<input type="checkbox"/> 24 24W	<input type="checkbox"/> 3 3000K
	<input type="checkbox"/> 35 35W	<input type="checkbox"/> 4 4000K
	<input type="checkbox"/> 51 51W	<input type="checkbox"/> 5 5000K

2640 LÚMENES
3850 LÚMENES
5610 LÚMENES

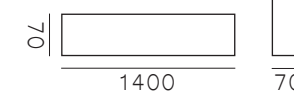
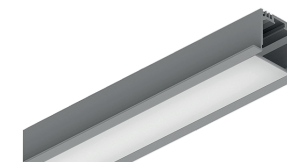

4850 A B C D

A-COLOR	B-POTENCIA	C-TONALIDAD
---------	------------	-------------

<input type="checkbox"/> BL BLANCO	<input type="checkbox"/> 30 30W	<input type="checkbox"/> 3 3000K
	<input type="checkbox"/> 44 44W	<input type="checkbox"/> 4 4000K
	<input type="checkbox"/> 64 64W	<input type="checkbox"/> 5 5000K

3300 LÚMENES
4840 LÚMENES
7070 LÚMENES



FABRICACIÓN A MEDIDA

STYLINE de superficie y suspensión A40

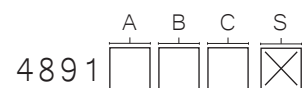

A-COLOR	B-POTENCIA	LÚMENES	C-TONALIDAD	APERTURA
<input type="checkbox"/> BL BLANCO	<input type="checkbox"/> 12 12W	1320	<input type="checkbox"/> 3 3000K	<input type="checkbox"/> 100°
<input checked="" type="checkbox"/> NG NEGRO	<input type="checkbox"/> 17 17W	1870	<input type="checkbox"/> 4 4000K	
<input type="checkbox"/> GR GRIS	<input type="checkbox"/> 25 25W	2750	<input type="checkbox"/> 5 5000K	

DIMENSIONES DIFUSOR ÁNGULO DE APERTURA

560X40X75mm

*Otras medidas a consultar

• OPAL

(Se suministrará de manera estandar)

• MICROPRISMÁTICO

• ASIMÉTRICO

• DE 100°



STYLINE de superficie y suspensión A40



1130X40X70 mm

*Otras medidas a consultar



A-COLOR	B-POTENCIA	LÚMENES	C-TONALIDAD	APERTURA
<input type="checkbox"/> BL BLANCO	<input type="checkbox"/> 24 24W	2640	<input type="checkbox"/> 3 3000K	<input type="checkbox"/> 100°
<input checked="" type="checkbox"/> NG NEGRO	<input type="checkbox"/> 35 35W	3850	<input type="checkbox"/> 4 4000K	
<input type="checkbox"/> GR GRIS	<input type="checkbox"/> 51 51W	5610	<input type="checkbox"/> 5 5000K	

DIFUSOR

• OPAL

(Se suministrará de manera estandar)

• MICROPRISMÁTICO

ÁNGULO DE APERTURA

• ASIMÉTRICO

• DE 100°

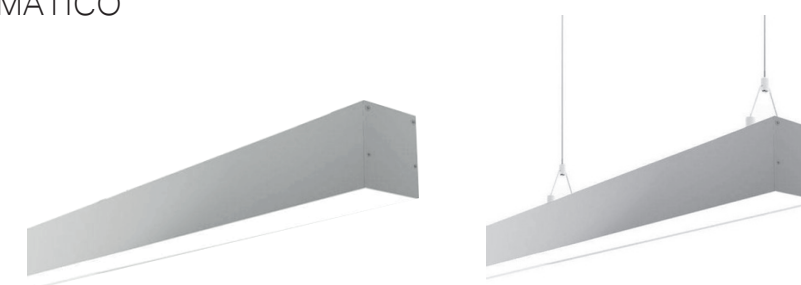

1400X40X70 mm

*Otras medidas a consultar

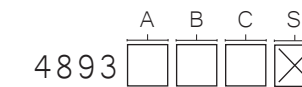

A-COLOR	B-POTENCIA	LÚMENES	C-TONALIDAD	APERTURA
<input type="checkbox"/> BL BLANCO	<input type="checkbox"/> 30 30W	3300	<input type="checkbox"/> 3 3000K	<input type="checkbox"/> 100°
<input checked="" type="checkbox"/> NG NEGRO	<input type="checkbox"/> 44 44W	4840	<input type="checkbox"/> 4 4000K	
<input type="checkbox"/> GR GRIS	<input type="checkbox"/> 64 64W	7040	<input type="checkbox"/> 5 5000K	

DIFUSOR

• OPAL

(Se suministrará de manera estandar)

• MICROPRISMÁTICO

ÁNGULO DE APERTURA

• ASIMÉTRICO

• DE 100°



STYLET BRILLO MODELO 1

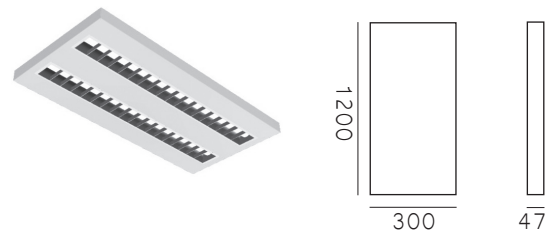

A-COLOR	B-POTENCIA	C-TONALIDAD
BL BLANCO	24 24W	4 4000K

4565

2400 LÚMENES

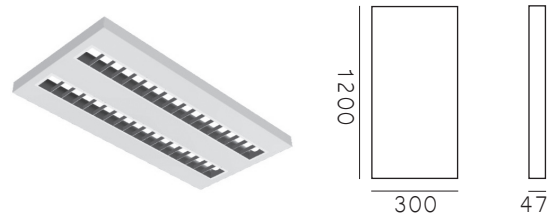

A-COLOR	B-POTENCIA	C-TONALIDAD
BL BLANCO	45 45W	4 4000K

4565

4500 LÚMENES

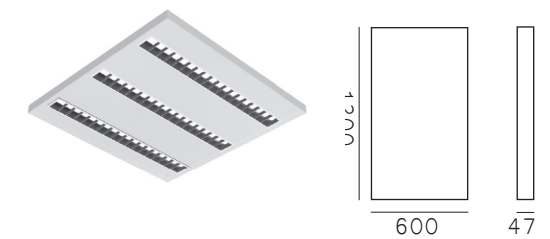

A-COLOR	B-POTENCIA	C-TONALIDAD
BL BLANCO	45 45W	4 4000K

4567

5300 LÚMENES

STYLET OPAL

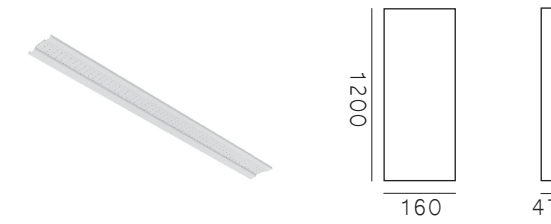

A-COLOR	B-POTENCIA	C-TONALIDAD
BL BLANCO	24 24W	4 4000K

4560

3880 LÚMENES

STYLET PRISMA

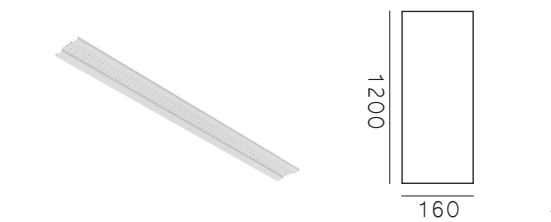

A-COLOR	B-POTENCIA	C-TONALIDAD
BL BLANCO	24 24W	4 4000K

4560

5820 LÚMENES
7935 LÚMENES

STYLET OPAL MODELO 2

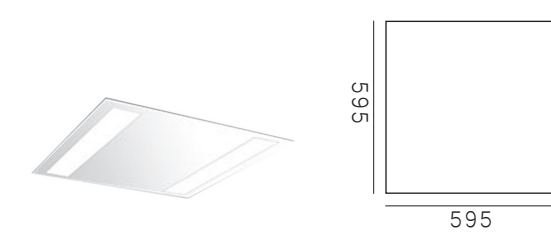

A-COLOR	B-POTENCIA	C-TONALIDAD
BL BLANCO	23 23W	4 4000K
	34 34W	

4550

3880 LÚMENES
5290 LÚMENES



STYLET OPAL MODELO 3

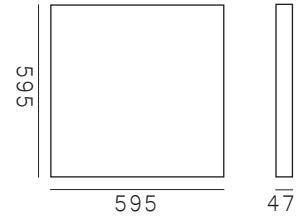
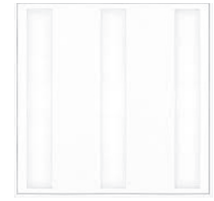

4551

A-COLOR C-TONALIDAD

A-COLOR	B-POTENCIA	C-TONALIDAD
<input type="checkbox"/> BL BLANCO	<input type="checkbox"/> 35 35W	<input type="checkbox"/> 4 4000K
<input type="checkbox"/> NG NEGRO	<input type="checkbox"/> 51 51W	

5820 LÚMENES
7935 LÚMENES

STYLET BRILLO

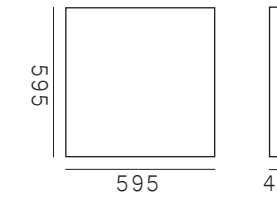

4557

A-COLOR B-POTENCIA C-TONALIDAD

A-COLOR	B-POTENCIA	C-TONALIDAD
<input type="checkbox"/> BL BLANCO	<input type="checkbox"/> 24 24W	<input type="checkbox"/> 4 4000K

2880 LÚMENES

STYLETA OPAL MODELO 2

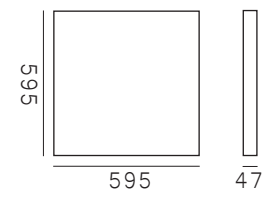

4564

A-COLOR B-POTENCIA C-TONALIDAD

A-COLOR	B-POTENCIA	C-TONALIDAD
<input type="checkbox"/> BL BLANCO	<input type="checkbox"/> 36 36W	<input type="checkbox"/> 4 4000K

D-REGULACIÓN

<input type="checkbox"/> RD REGULACIÓN DALI

4000 LÚMENES

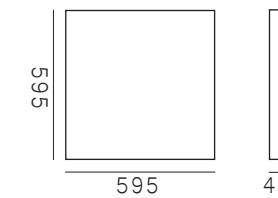
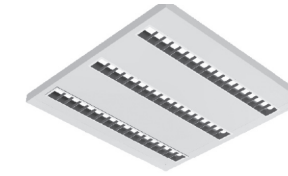

4558

A-COLOR B-POTENCIA C-TONALIDAD

A-COLOR	B-POTENCIA	C-TONALIDAD
<input type="checkbox"/> BL BLANCO	<input type="checkbox"/> 35 35W	<input type="checkbox"/> 4 4000K
	<input type="checkbox"/> 51 51W	

5820 LÚMENES
7935 LÚMENES

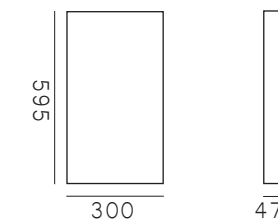
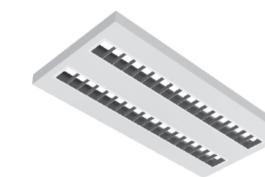

4559

A-COLOR B-POTENCIA C-TONALIDAD

A-COLOR	B-POTENCIA	C-TONALIDAD
<input type="checkbox"/> BL BLANCO	<input type="checkbox"/> 35 35W	<input type="checkbox"/> 4 4000K

3880 LÚMENES



ULTRA G2

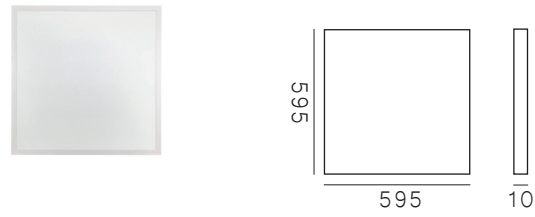

A-COLOR B-POTENCIA C-TONALIDAD

BL BLANCO 36 36W 4 4000K

D-REGULACIÓN

RD REGULACIÓN DALI

4400 4000 LÚMENES

4400 A B C D

ULTRA

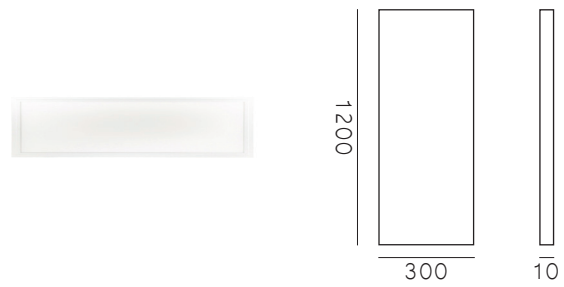

A-COLOR B-POTENCIA C-TONALIDAD

BL BLANCO 40 40W 4 4000K

D-REGULACIÓN

RD REGULACIÓN DALI

4401 4000 LÚMENES

4401 A B C D

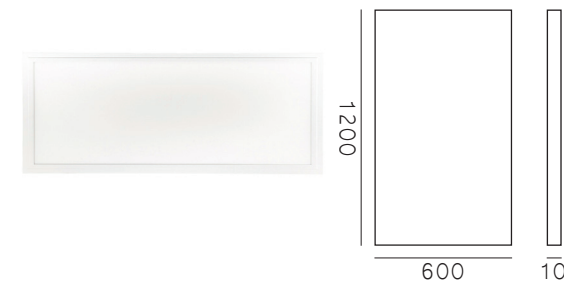

A-COLOR B-POTENCIA C-TONALIDAD

BL BLANCO 70 70W 4 4000K

D-REGULACIÓN

RD REGULACIÓN DALI

4402 7000 LÚMENES

4402 A B C D

ULTRA UGR19

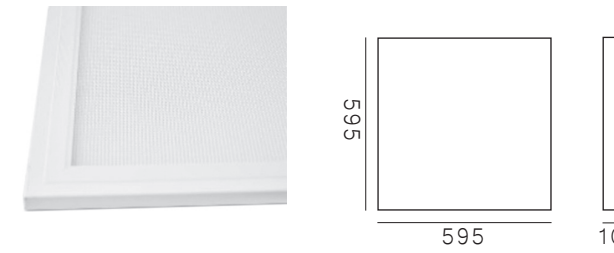

A-COLOR B-POTENCIA C-TONALIDAD

BL BLANCO 40 40W 4 4000K

D-REGULACIÓN

RD REGULACIÓN DALI

4220 4000 LÚMENES

4220 A B C D

ULTRA UGR17

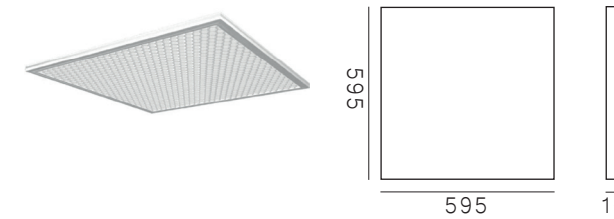

A-COLOR B-POTENCIA C-TONALIDAD

BL BLANCO 40 40W 4 4000K

D-REGULACIÓN

RD REGULACIÓN DALI

4220 4000 LÚMENES

4220 A B C D

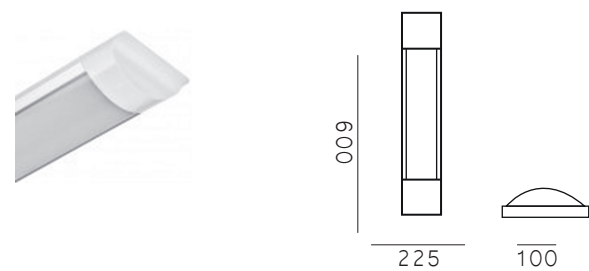

A-COLOR	B-POTENCIA	C-TONALIDAD
BL BLANCO	18 18W	4 4000K
		6 6000K

3001

1800 LÚMENES

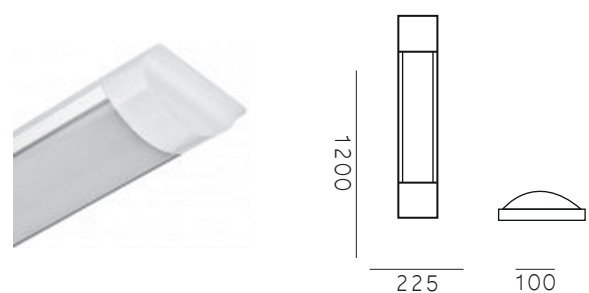

A-COLOR	B-POTENCIA	C-TONALIDAD
BL BLANCO	40 40W	4 4000K
		6 6000K

3001

4000 LÚMENES

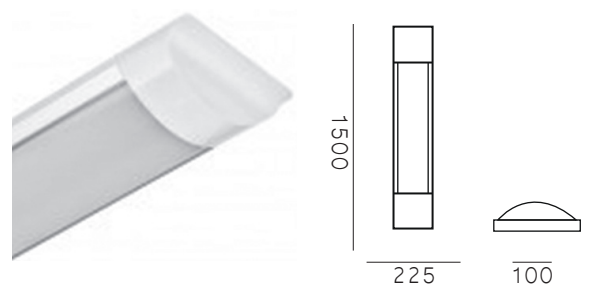

A-COLOR	B-POTENCIA	C-TONALIDAD
BL BLANCO	60 60W	4 4000K
		6 6000K

3001

6000 LÚMENES





INDUSTRIAL

Luminarias de fabricación a medida, formatos en chapa y aluminio de alta calidad.

Instalación para superficie o suspensión.

Transmite y distribuye la luz LED con diferentes difusores para cumplir con los niveles más exigentes.

Ideal para la instalación en techos.

Aplicación para naves e industria.

ARENOL G2 IP65

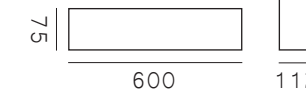

3000 A B C D

A-COLOR B-POTENCIA C-TONALIDAD

BL BLANCO 18 18W 4 4000K

IP65

2000 LÚMENES

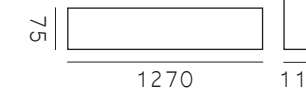

3000 A B C D

A-COLOR B-POTENCIA C-TONALIDAD

BL BLANCO 36 36W 4 4000K

IP65

4000 LÚMENES

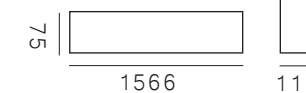

3000 A B C D

A-COLOR B-POTENCIA C-TONALIDAD

BL BLANCO 45 45W 4 4000K

IP65

6000 LÚMENES

NILOXOM IP65

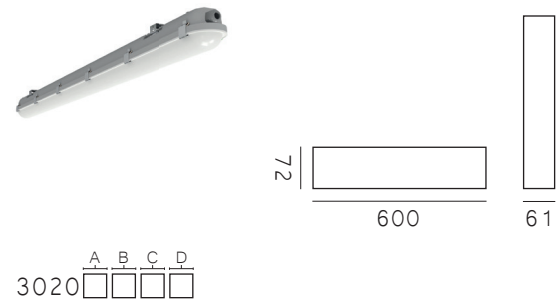

A-COLOR	B-POTENCIA	C-TONALIDAD
BL BLANCO	18 18W	4 4000K

2200 LÚMENES

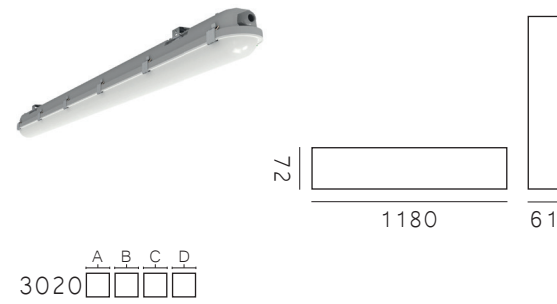

A-COLOR	B-POTENCIA	C-TONALIDAD
BL BLANCO	40 40W	4 4000K

4200 LÚMENES

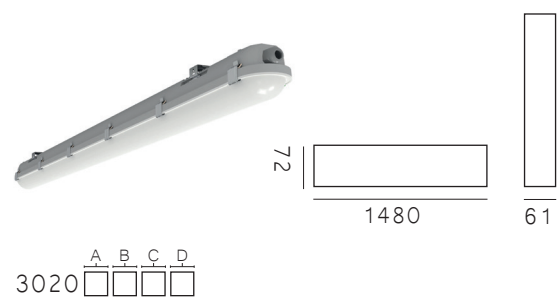

A-COLOR	B-POTENCIA	C-TONALIDAD
BL BLANCO	55 55W	4 4000K

5500 LÚMENES

ARENOL MAX IP65

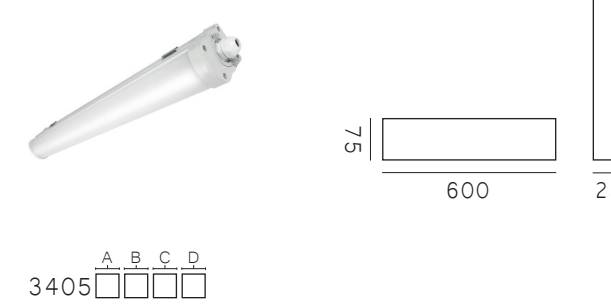

A-COLOR	B-POTENCIA	C-TONALIDAD
BL BLANCO	19 19W	4 4000K

2400 LÚMENES

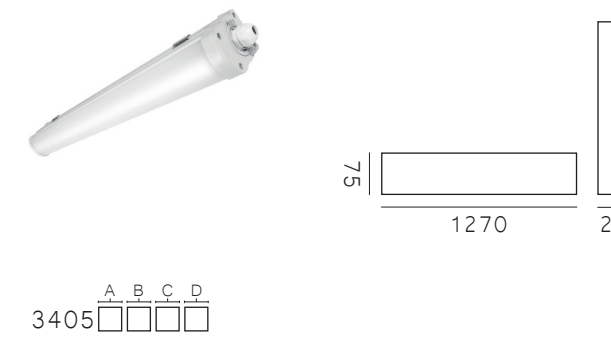

A-COLOR	B-POTENCIA	C-TONALIDAD
BL BLANCO	35 35W	4 4000K

4550 LÚMENES

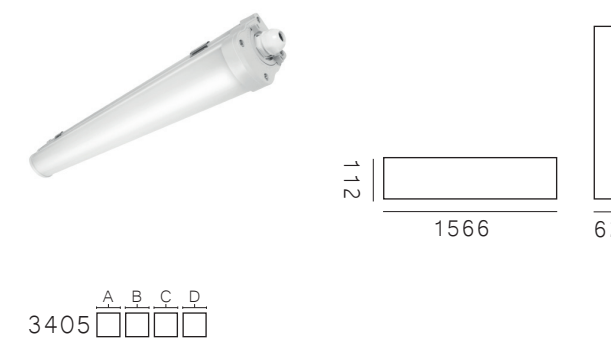

A-COLOR	B-POTENCIA	C-TONALIDAD
BL BLANCO	45 45W	4 4000K

5850 LÚMENES



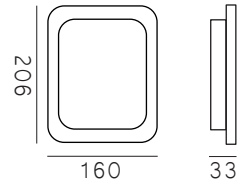

8 1 1 0

A-COLOR	B-POTENCIA	C-TONALIDAD
<input type="checkbox"/> BL BLANCO	<input type="checkbox"/> 10 10W	<input type="checkbox"/> 3 3000K
<input type="checkbox"/> NG NEGRO		<input type="checkbox"/> 4 4000K
		<input type="checkbox"/> 6 6000K
APERTURA		
<input type="checkbox"/> 120°		
120 LÚMENES/W		<input type="checkbox"/> VIDA ÚTIL 95000 HORAS <input type="checkbox"/> IP65

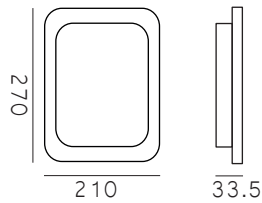

8 1 1 0

A-COLOR	B-POTENCIA	C-TONALIDAD
<input type="checkbox"/> BL BLANCO	<input type="checkbox"/> 20 20W	<input type="checkbox"/> 3 3000K
<input type="checkbox"/> NG NEGRO		<input type="checkbox"/> 4 4000K
		<input type="checkbox"/> 6 6000K
APERTURA		
<input type="checkbox"/> 120°		
120 LÚMENES/W		<input type="checkbox"/> VIDA ÚTIL 95000 HORAS <input type="checkbox"/> IP65

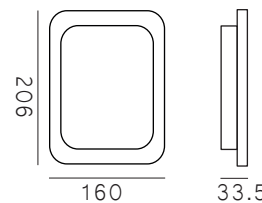

8 1 1 0

A-COLOR	B-POTENCIA	C-TONALIDAD
<input type="checkbox"/> BL BLANCO	<input type="checkbox"/> 30 30W	<input type="checkbox"/> 3 3000K
<input type="checkbox"/> NG NEGRO		<input type="checkbox"/> 4 4000K
		<input type="checkbox"/> 6 6000K
APERTURA		
<input type="checkbox"/> 120°		
120 LÚMENES/W		<input type="checkbox"/> VIDA ÚTIL 95000 HORAS <input type="checkbox"/> IP65

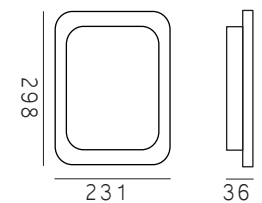

8 1 1 0

A-COLOR	B-POTENCIA	C-TONALIDAD
<input type="checkbox"/> BL BLANCO	<input type="checkbox"/> 50 50W	<input type="checkbox"/> 3 3000K
<input type="checkbox"/> NG NEGRO		<input type="checkbox"/> 4 4000K
		<input type="checkbox"/> 6 6000K
APERTURA		
<input type="checkbox"/> 120°		
120 LÚMENES/W		<input type="checkbox"/> VIDA ÚTIL 95000 HORAS <input type="checkbox"/> IP65

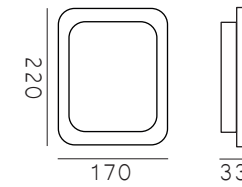

8 1 1 0

A-COLOR	B-POTENCIA	C-TONALIDAD
<input type="checkbox"/> BL BLANCO	<input type="checkbox"/> 100 100W	<input type="checkbox"/> 3 3000K
<input type="checkbox"/> NG NEGRO		<input type="checkbox"/> 4 4000K
		<input type="checkbox"/> 6 6000K
APERTURA		
<input type="checkbox"/> 120°		
120 LÚMENES/W		<input type="checkbox"/> VIDA ÚTIL 95000 HORAS <input type="checkbox"/> IP65

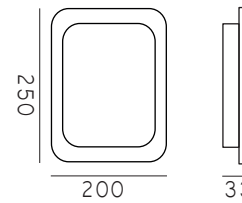

8 1 1 0

A-COLOR	B-POTENCIA	C-TONALIDAD
<input type="checkbox"/> BL BLANCO	<input type="checkbox"/> 150 150W	<input type="checkbox"/> 3 3000K
<input type="checkbox"/> NG NEGRO		<input type="checkbox"/> 4 4000K
		<input type="checkbox"/> 6 6000K
APERTURA		
<input type="checkbox"/> 120°		
120 LÚMENES/W		<input type="checkbox"/> VIDA ÚTIL 95000 HORAS <input type="checkbox"/> IP65

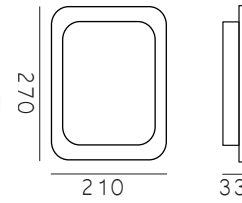

8 1 1 0

A-COLOR	B-POTENCIA	C-TONALIDAD
<input type="checkbox"/> BL BLANCO	<input type="checkbox"/> 200 200W	<input type="checkbox"/> 3 3000K
<input type="checkbox"/> NG NEGRO		<input type="checkbox"/> 4 4000K
		<input type="checkbox"/> 6 6000K
APERTURA		
<input type="checkbox"/> 120°		
120 LÚMENES/W		<input type="checkbox"/> VIDA ÚTIL 95000 HORAS <input type="checkbox"/> IP65

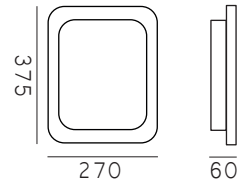

8320

A-COLOR	B-POTENCIA	C-TONALIDAD
NG NEGRO	<input type="checkbox"/> 10W <input type="checkbox"/> 30W <input type="checkbox"/> 50W	<input type="checkbox"/> 5 5000K
APERTURA		
<input type="checkbox"/> 90°		
VIDA ÚTIL 95000 HORAS <input type="checkbox"/> IP65		
12000 LÚMENES		

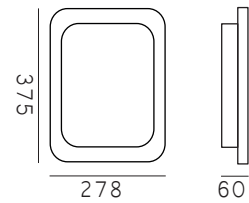

8320

A-COLOR	B-POTENCIA	C-TONALIDAD
NG NEGRO	<input type="checkbox"/> 20W <input type="checkbox"/> 100W <input type="checkbox"/> 200W	<input type="checkbox"/> 5 5000K
APERTURA		
<input type="checkbox"/> 90°		
VIDA ÚTIL 95000 HORAS <input type="checkbox"/> IP65		
18000 LÚMENES		

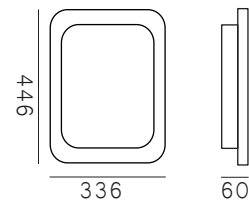

8320

A-COLOR	B-POTENCIA	C-TONALIDAD
NG NEGRO	<input type="checkbox"/> 20W <input type="checkbox"/> 100W <input type="checkbox"/> 200W	<input type="checkbox"/> 5 5000K
APERTURA		
<input type="checkbox"/> 90°		
VIDA ÚTIL 95000 HORAS <input type="checkbox"/> IP65		
24000 LÚMENES		

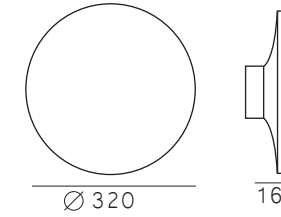

8050

A-COLOR	B-POTENCIA	C-TONALIDAD
NG NEGRO	<input type="checkbox"/> 100W <input type="checkbox"/> 150W <input type="checkbox"/> 200W	<input type="checkbox"/> 5 5000K
SENSOR DE REGULACIÓN		APERTURA
SR-110		<input type="checkbox"/> 90°
15000 LÚMENES 22000 LÚMENES 30000 LÚMENES		<input type="checkbox"/> IP65

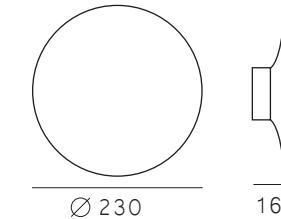

8002

A-COLOR	B-POTENCIA	C-TONALIDAD
NG NEGRO	<input type="checkbox"/> 100W <input type="checkbox"/> 150W <input type="checkbox"/> 200W	<input type="checkbox"/> 6 6000K
APERTURA		<input type="checkbox"/> 120°
VIDA ÚTIL 95000 HORAS		<input type="checkbox"/> IP65



SUPERLINE SUSPENSION

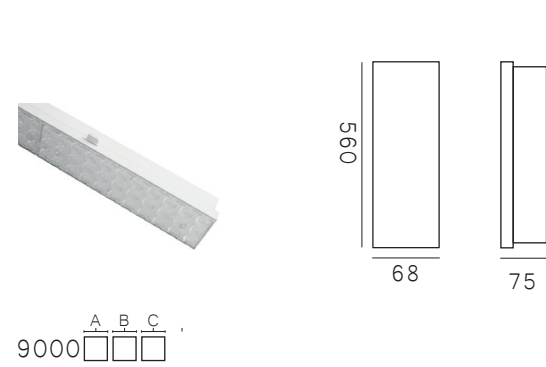

A-COLOR	B-POTENCIA	C-TONALIDAD
BL BLANCO	12 12W	4 4000K

D-REGULACIÓN

RD REGULACIÓN DALI

2040 LÚMENES IP54

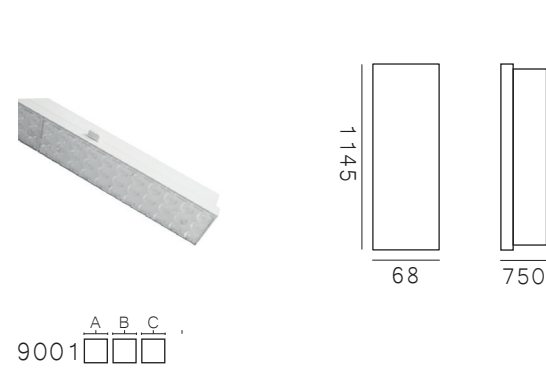

A-COLOR	B-POTENCIA	C-TONALIDAD
BL BLANCO	24 24W 69 69W	4 4000K

D-REGULACIÓN

RD REGULACIÓN DALI

4080 LÚMENES
9540 LÚMENES IP54

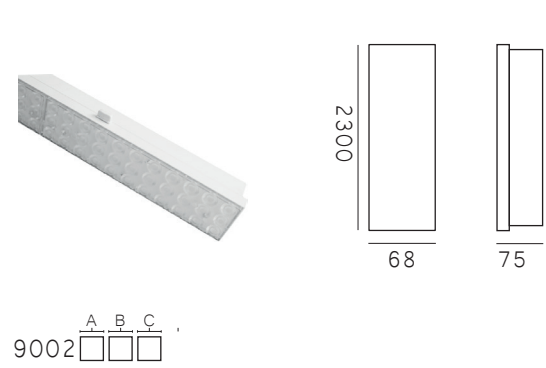

A-COLOR	B-POTENCIA	C-TONALIDAD
BL BLANCO	49 49W	4 4000K

D-REGULACIÓN

RD REGULACIÓN DALI

8160 LÚMENES IP54

SUPERLINE

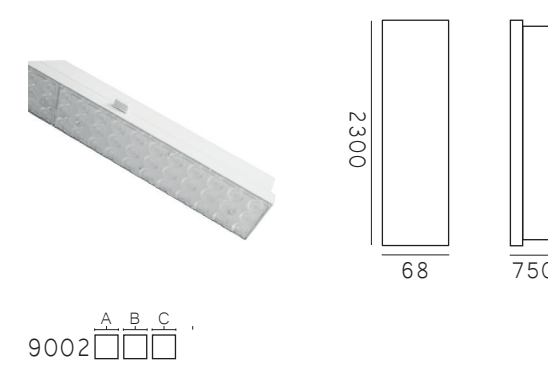

A-COLOR	B-POTENCIA	C-TONALIDAD
BL BLANCO	138 138W	4 4000K

D-REGULACIÓN

RD REGULACIÓN DALI

19080 LÚMENES IP54

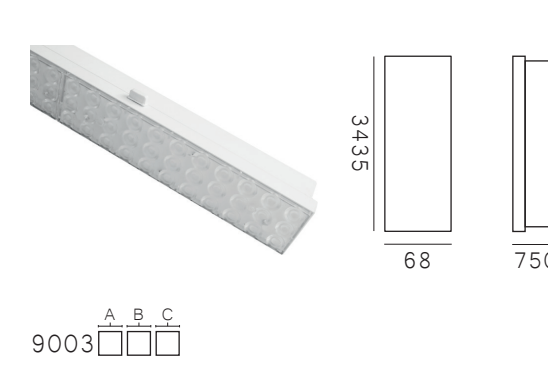

A-COLOR	B-POTENCIA	C-TONALIDAD
BL BLANCO	74 74W	4 4000K

D-REGULACIÓN

RD REGULACIÓN DALI

12240 LÚMENES IP54

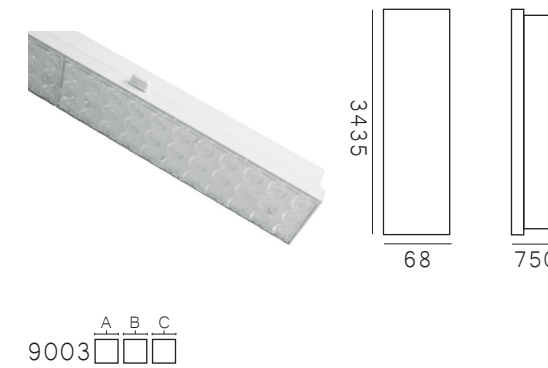

A-COLOR	B-POTENCIA	C-TONALIDAD
BL BLANCO	207 207W	4 4000K

D-REGULACIÓN

RD REGULACIÓN DALI

28620 LÚMENES IP54

mmnnnn

HOSPITALES

STYLET IP65

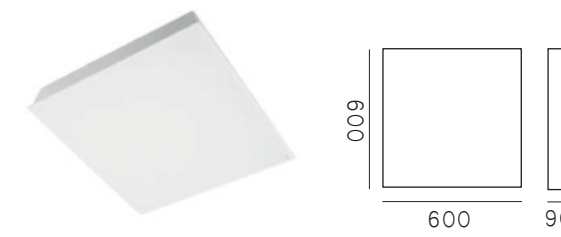

4580

A	B	C	D
□	□	□	□

A-COLOR	B-POTENCIA	C-TONALIDAD
BL BLANCO	38 38W	4 4000K

6000 LÚMENES

IP65

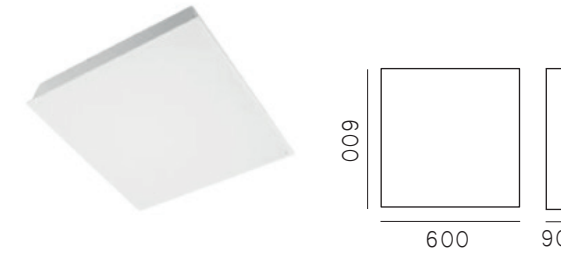

4580

A	B	C	D
□	□	□	□

A-COLOR	B-POTENCIA	C-TONALIDAD
BL BLANCO	48 48W	4 4000K

7260 LÚMENES

IP65

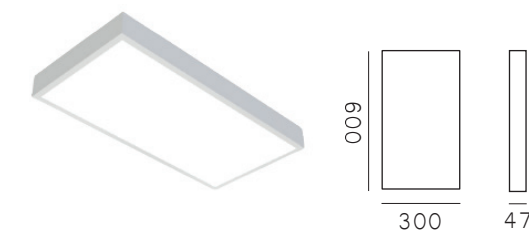

4581

A	B	C	D
□	□	□	□

A-COLOR	B-POTENCIA	C-TONALIDAD
BL BLANCO	22 22W	3 3000K

3460 LÚMENES

IP65

Luminarias de fabricación a medida, formatos en chapa y aluminio de alta calidad.

Instalación para superficie o suspensión.

Transmite y distribuye la luz LED con diferentes difusores para cumplir con los niveles más exigentes.

Ideal para la instalación en techos.

Aplicación para hospitales o laboratorios.



STYLET IP65 POLIVALENTE

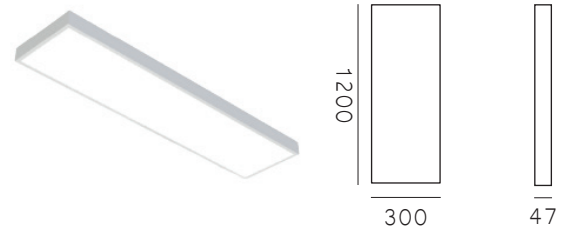

A-COLOR	B-POTENCIA	C-TONALIDAD
BL BLANCO	38 38W	4 4000K

4582

A	B	C	D
□	□	□	□

4560 LÚMENES

IP65

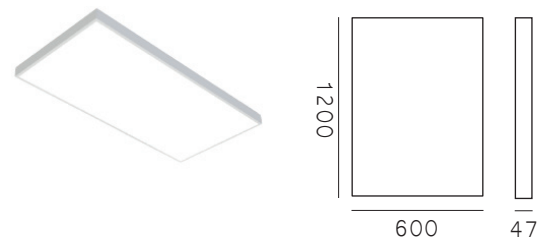

A-COLOR	B-POTENCIA	C-TONALIDAD
BL BLANCO	76 76W	4 4000K

4583

A	B	C	D
□	□	□	□

8000LÚMENES

IP65



DEPORTIVA

Luminarias de fabricación especial, totalmente en aluminio y ópticas adaptadas para las diferentes instalaciones.

Sistema de superficie, tanto en interior como exterior.

Transmite y distribuye la luz LED con diferentes ópticas para cumplir con los niveles más exigentes de las instalaciones deportivas.

Ideal para la soportación en columnas y torretas.

Aplicación para instalaciones deportivas.

KUESTRA G2

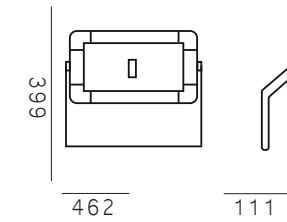

A-COLOR	B-POTENCIA	C-TONALIDAD
GR GRIS	250 250W	6 6000K



APERTURA		
		25°
		45°
		60°
		90°

33600 LÚMENES

IK08	IP66
------	------

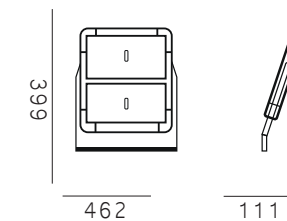
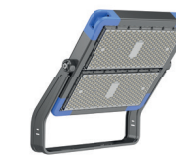

A-COLOR	B-POTENCIA	C-TONALIDAD
GR GRIS	500 500W	6 6000K



APERTURA		
		25°
		45°
		60°
		90°

67200 LÚMENES

IK08	IP66
------	------

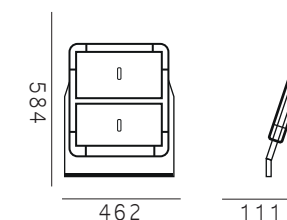

A-COLOR	B-POTENCIA	C-TONALIDAD
GR GRIS	750 750W	6 6000K

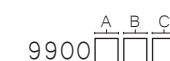

APERTURA		
		25°
		45°
		60°
		90°

100800 LÚMENES

IK08	IP66
------	------

KUESTRA V1000

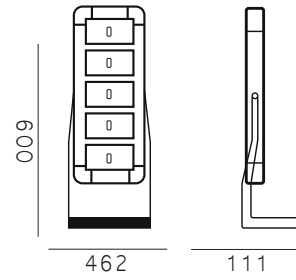

A-COLOR B-POTENCIA C-TONALIDAD

GR GRIS 1000 1000W 6 6000K

APERTURA

25°

45°

60°

90°

134440 LÚMENES

IK08

IP66

9900 A B C

KUESTRA V1250

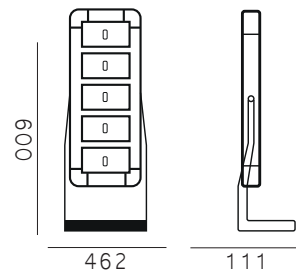

A-COLOR B-POTENCIA C-TONALIDAD

GR GRIS 1250 1250W 6 6000K

APERTURA

25°

45°

60°

90°

175500 LÚMENES

IK08

IP66

9900 A B C

PROTECTOR SOBRETENSIONES



Protector sobretensiones 10KV. IP66

PS

VISERA PROYECTOR



V



UNIKO



A-COLOR	B-POTENCIA	C-TONALIDAD
GR ALUMINIO	200 200W	5 57000K

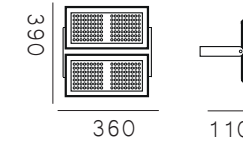

9 125

A	B	C
<input type="checkbox"/>	<input type="checkbox"/>	<input type="checkbox"/>

IK08

VIDA UTIL 50000 HORAS

 IP66

A-COLOR	B-POTENCIA	C-TONALIDAD
GR ALUMINIO	400 400W	5 57000K

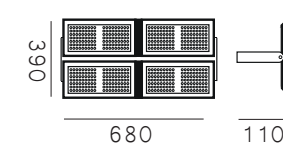

9 125

A	B	C
<input type="checkbox"/>	<input type="checkbox"/>	<input type="checkbox"/>

IK08

VIDA UTIL 50000 HORAS

 IP66

EXTERIOR

OBBO G2 OVALADO

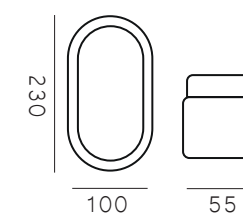

8911

A-COLOR B-POTENCIA C-TONALIDAD

BL BLANCO 12 12W 4 4000K

1200 LÚMENES

IP65

OBBO G2 CIRCULAR

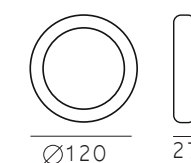

8912

A-COLOR B-POTENCIA C-TONALIDAD

BL BLANCO 8 8W
 18 18W 4 4000K

800 LÚMENES
1800 LÚMENES

IP65

Luminarias para exterior.
 Instalación para superficie o para empotrar mediante sistemas estancos.
 Iluminación para jardines.
 Ideal para suelos o paredes.
 Aplicación para vivienda, hostelería, hoteles...

HAYL CIRCULAR E-27



Cuerpo de policarbonato tratado ,portalamparas E-27. Incluye casquillo e-27conexiones



8612

A	B	C

IP65 IK10

HAYL OVALADO E-27



Cuerpo de policarbonato tratado ,portalamparas E-27. Incluye casquillo e-27conexiones

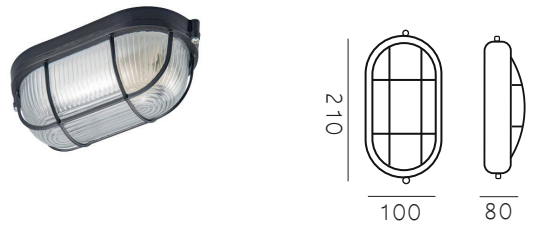

8613

A	B	C

IP65 IK10

SCISOR CILÍNDRICO 1L



A-COLOR	B-POTENCIA	C-TONALIDAD
BL BLANCO	7 7W	3 3000K
GR GRIS		
NG NEGRO		

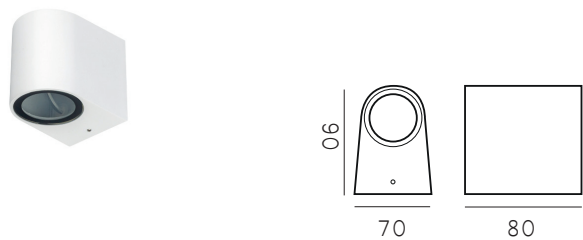

8950

A	B	C

IP54

SCISOR RECTANGULAR 1L



A-COLOR	B-POTENCIA	C-TONALIDAD
BL BLANCO	7 7W	3 3000K
GR GRIS		
NG NEGRO		

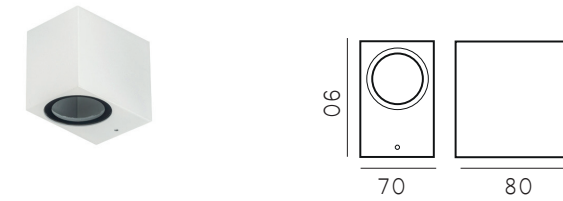

8955

A	B	C

IP54

SCISOR RECTANGULAR 2L



A-COLOR	B-POTENCIA	C-TONALIDAD
BL BLANCO	14 14W	3 3000K
GR GRIS		
NG NEGRO		



8956

A	B	C

IP54

SCISOR CILÍNDRICO 2L



A-COLOR	B-POTENCIA	C-TONALIDAD
BL BLANCO	14 14W	3 3000K
GR GRIS		
NG NEGRO		

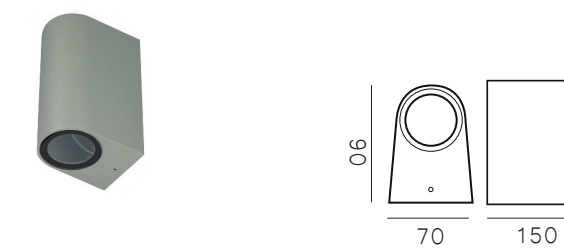

8951

A	B	C

IP54



SUPERFICIE

NIOXX VERTICAL

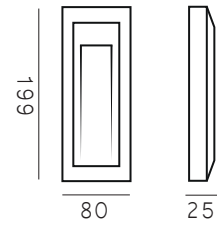

A-COLOR	B-POTENCIA	C-TONALIDAD
GR GRIS	1 1W	4 4000K

8953

A	B	C
□	□	□

90 LÚMENES

IP66

NIOXX CIRCULAR INDIRECTO

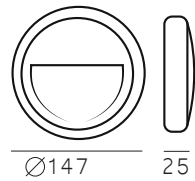

A-COLOR	B-POTENCIA	C-TONALIDAD
GR GRIS	1,5 1,5W	4 4000K

8911

A	B	C
□	□	□

126 LÚMENES

IP66

NIOXX CIRCULAR DIRECTO

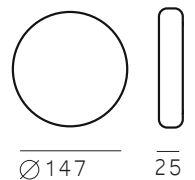

A-COLOR	B-POTENCIA	C-TONALIDAD
GR GRIS	3 3W	4 4000K

8912

A	B	C
□	□	□

298 LÚMENES

IP66

SUPERFICIE

NIOXX HORIZONTAL DIRECTO

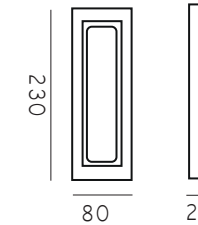

A-COLOR	B-POTENCIA	C-TONALIDAD
GR GRIS	3,5 3,5W	4 4000K

8341

A	B	C
□	□	□

260 LÚMENES

IP66

NIOXX HORIZONTAL INDIRECTO

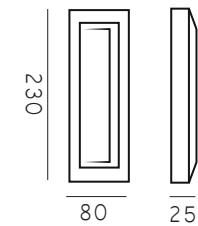

A-COLOR	B-POTENCIA	C-TONALIDAD
GR GRIS	2 2W	4 4000K

8342

A	B	C
□	□	□

170 LÚMENES

IP66

NIOXX CUADRADO INDIRECTO

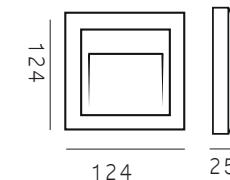

A-COLOR	B-POTENCIA	C-TONALIDAD
GR GRIS	1,5 1,5W	4 4000K

8343

A	B	C
□	□	□

95 LÚMENES

IP66



SUPERFICIE
 REGELN CIRCULAR

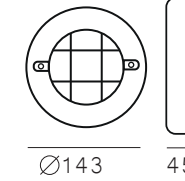

8344

A-COLOR	B-POTENCIA	C-TONALIDAD
NG NEGRO	3,8 3,8W	4 4000K

366 LÚMENES

IP66

REGELN CIRCULAR INDIRECTO

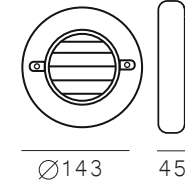

8345

A-COLOR	B-POTENCIA	C-TONALIDAD
NG NEGRO	3,8 3,8W	4 4000K

366 LÚMENES

IP54

MUNY

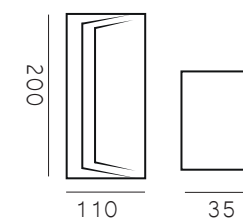

8879

A-COLOR	B-POTENCIA	C-TONALIDAD
GR GRIS	6 6W	4 4000K

510 LÚMENES

IP66

SUPERFICIE

MUNY MAX RECTANGULAR



A-COLOR	B-POTENCIA	C-TONALIDAD
GR GRIS	12 12W	3 3000K 4 4000K

8879

1275 LÚMENES

IP65

EMPOTRADOS

MICRO SUNI IP65

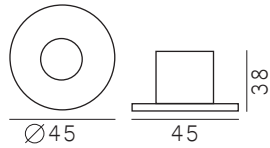

3436

A-COLOR	B-POTENCIA	C-TONALIDAD
NG NEGRO	1 1W	3 3000K 4 4000K

100 LÚMENES

APERTURA
15°

VIDA ÚTIL
50000
HORAS IP65

EMPOTRADOS

XILEF IP65

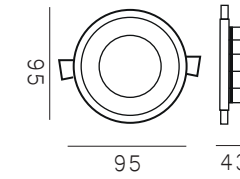

3350

A-COLOR	B-POTENCIA	C-TONALIDAD
BL BLANCO	7 7W 18 18W	3 3000K 4 4000K

650 LÚMENES
1750 LÚMENES

APERTURA
90°

IP65

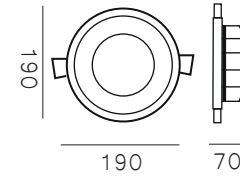

3350

A-COLOR	B-POTENCIA	C-TONALIDAD
BL BLANCO	7 7W 18 18W	3 3000K 4 4000K

650 LÚMENES
1750 LÚMENES

APERTURA
90°

IP65

FURKO INDIRECTO

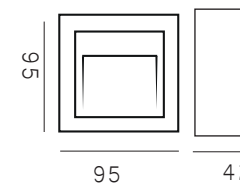

6892

A-COLOR	B-POTENCIA	C-TONALIDAD
BL BLANCO	3 3W	4 4000K
GR GRIS		
NG NEGRO		

90 LÚMENES

IP65

EMPOTRADOS

NIOXX MAX VERTICAL INDIRECTO

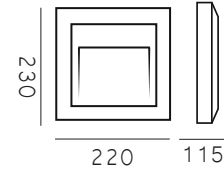

A-COLOR	B-POTENCIA	C-TONALIDAD
GR GRIS	10 10W	4 4000K

8893

A	B	C
□	□	□

850 LÚMENES

IP66

NIOXX VERTICAL INDIRECTO

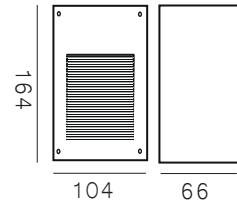

A-COLOR	B-POTENCIA	C-TONALIDAD
GR GRIS	3 3W	4 4000K

8891

A	B	C
□	□	□

300 LÚMENES

IP66

EMPOTRADOS

NIOXX HORIZONTAL INDIRECTO

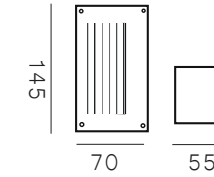

A-COLOR	B-POTENCIA	C-TONALIDAD
GR GRIS	3 3W	4 4000K

8896

A	B	C
□	□	□

150 LÚMENES

IP66

A-COLOR	B-POTENCIA	C-TONALIDAD
GR GRIS	5 5W	4 4000K

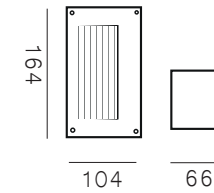
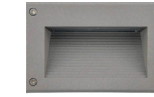

8896

A	B	C
□	□	□

399 LÚMENES

IP66



EMPOTRADOS

YAEK CIRCULAR

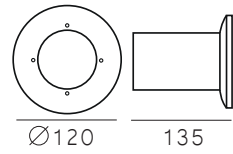

A-COLOR	B-POTENCIA	C-TONALIDAD
AX INOX	3 3W	4 4000K

8865

IP65

YAEK CUADRADO

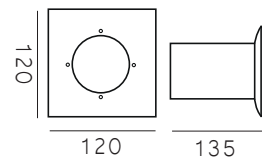

A-COLOR	B-POTENCIA	C-TONALIDAD
AX INOX	3 3W	4 4000K

8866

IP65

BALIS

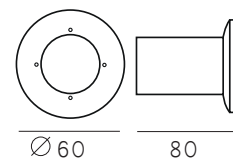

A-COLOR	B-POTENCIA	C-TONALIDAD
AX INOX	3 3W	4 4000K

8912

90 LÚMENES

IP66

EMPOTRADOS

BHEREI

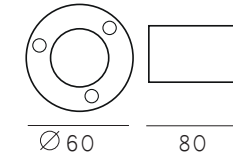

A-COLOR	B-POTENCIA	C-TONALIDAD
AX INOX	1 1W	4 4000K

8867

IP66

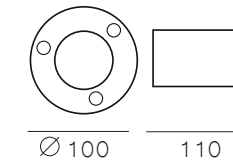

A-COLOR	B-POTENCIA	C-TONALIDAD
AX INOX	3 3W	4 4000K

8867

280 LÚMENES

IP66

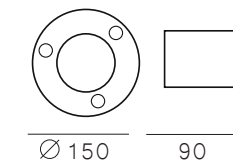

A-COLOR	B-POTENCIA	C-TONALIDAD
AX INOX	6 6W	4 4000K

8867

580 LÚMENES

IP66



MODELO MX7

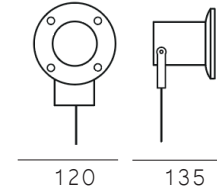

A-COLOR	B-POTENCIA	C-TONALIDAD
GR GRIS	7 7W	4 4000K

8963

A	B	C
<input type="checkbox"/>	<input type="checkbox"/>	<input type="checkbox"/>

IP65

SISTEMAS DE CONTROL

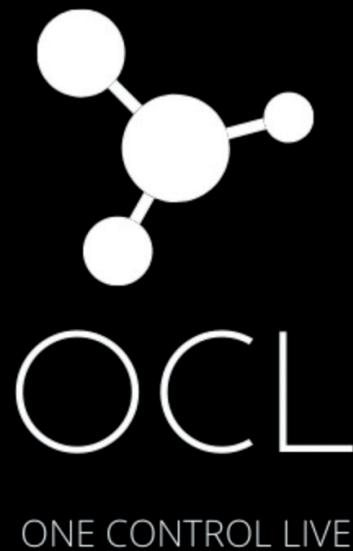

Luminarias con sensor de movimiento.
Instalación para superficie o para empotrar mediante sistemas estancos.
Ideal para espacios con mucho trasiego.
Aplicación para vivienda, hostelería, hoteles...

HOTELES



- Selección de escenas para crear el ambiente adecuado
- Completamente escalable, desde una habitación individual hasta una solución integrada de iluminación de todo el edificio
- Integración con Sistema de Gestión de Habitaciones
- Integración con Sistema Audio-Video
- Control de múltiples tipos de cargas
- Monitorización de Energía y Mantenimiento
- Encendido al Último Nivel (tras fallo de alimentación)
- Control Automático de los Espacios Públicos

OFICINAS



- Soluciones totalmente escalables, desde una oficina simple hasta la totalidad del edificio
- Gestión de la luz diurna para ahorro de energía
- Función Pasillo distribuidor para seguridad y confort
- Detección de Presencia / Ausencia coordinadas
- Integración con Sistema de Gestión de Edificio/ Sistema Audio-Video
- Monitorización de Energía y Mantenimiento
- Control de múltiples tipos de cargas
- Control de Persianas



CENTROS COMERCIALES



- Control Automático para ahorro de energía
- Selección de Escenas para crear el ambiente adecuado para sus clientes
- Monitorización de Energía y Mantenimiento
- Control de múltiples tipos de carga
- Integración con Sistema Audio-Video
- Integración con BMS, Sistema de Gestión de Edificio
- Gestión de la luz diurna y Detección de presencia para ahorro de energía
- Encendido al Último Nivel (tras fallo de alimentación)

CENTROS DE SALUD

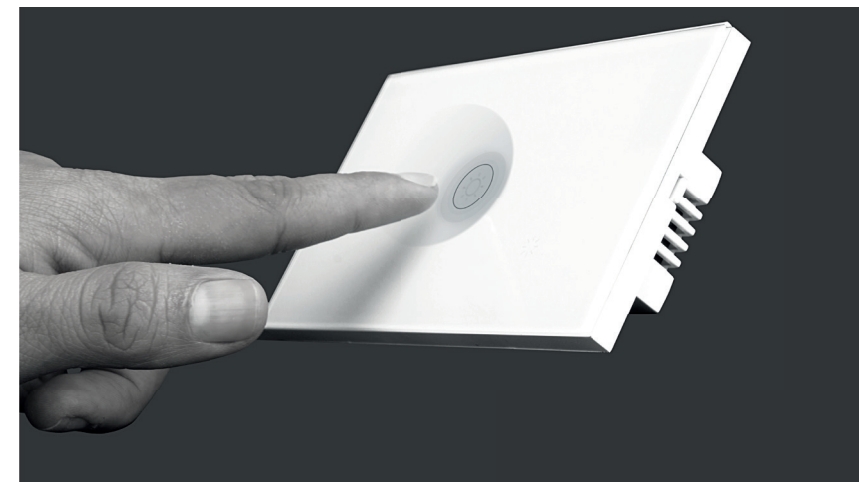

- Control sencillo para confort del paciente
- Iluminación de reconocimiento para personal médico
- Control Automático para Ahorro de Energía
- Soluciones completamente escalables, desde una cama individual al completo edificio
- Detección de Presencia / Ausencia
- Encendido al Último Nivel (tras fallo de alimentación)
- Integración con BMS, Sistema de Gestión de Edificio
- Gestión de Energía y Control



CONDICIONES GENERALES DE VENTA

GENERALES

Las luminarias están sujetas al periodo de garantía establecido en el RDL 1/2007, todos los productos tienen 2 años de garantía del fabricante desde la fecha de entrega del producto salvo que se establezca un periodo de duración superior.

Las reclamaciones por defectos ocultos serán atendidas conforme al Real Decreto Legislativo 1/2007, de 16 de noviembre, por el que se aprueba el texto refundido de la Ley General para la Defensa de los Consumidores y Usuarios y otras leyes complementarias (en adelante RDL 1/2007).

85 LIGHTING, no se hace responsable de los problemas por las posibles erratas que aparecen en el catálogo.

GARANTIA

Las garantías tienen validez a partir de la fecha de recepción del producto. Es necesario presentar la factura de compra como justificante y el documento de recepción de la misma, en su caso.

85 LIGHTING, se responsabiliza de la calidad de sus luminarias siempre que se sigan las recomendaciones indicadas y declinará toda responsabilidad por:

- POR MAL ALMACENAMIENTO.
- POR MALA INSTALACIÓN.
- EN CAJAS HUMEDAS
- SIN PINTURA, YESO O RESTOS DE OBRAS.
- CON SU CAJA ORIGINAL.

PLAZOS DE ENTREGA

Los plazos de entrega se confirmarán a partir del pedido en fábrica y siempre se darán en días laborables.

Portes inferior a 600€ , 10€ en envío.



RECLAMACIONES

Las reclamaciones por incidencias de cantidad u otros defectos del producto suministrado no se admitirán pasados 24 Horas a partir de la fecha de recepción de las mismas.

Cualquier incidencia por parte de la agencia de transporte , será esta misma la que se haga cargo de la mercancía y su gestión.

DEVOLUCIONES

85 LIGHTING no admitirá ninguna devolución de mercancía sin previo aviso a 85 LIGHTING. Todas las devoluciones tienen que ir acompañadas de la autorización de 85 LIGHTING.

No se admitirán devoluciones de material de fabricación especial o a medida para proyectos. Las devoluciones de material en buen estado propiedad del cliente, se admitirán bajo las siguientes condiciones:

- Antigüedad del material menor a 30 días y en perfectas condiciones , se admite devolución.
- Mayor de 3 meses, no se admite devolución.
- Las devoluciones se deberán realizar a portes pagados.

CANCELACIÓN DE PEDIDOS

Una vez recibido un pedido en nuestras oficinas, de luminarias especiales o de luminarias que no sean de tecnología LED, y transcurridas 48 horas desde su recepción, éste no podrá ser cancelado sin previa autorización por escrito de 85 LIGHTING.

FORMA DE PAGO

85 lighting . pone a disposición del cliente distintas formas de pago encontrar:

- Pago por transferencia/ingreso bancario
- Pago mediante aseguradoras de cobros .

85 lighting . puede ampliar o reducir el número de las formas de pago en todo momento. El cliente seleccionará la forma de pago elegida entre las disponibles en el momento de realizar la compra.